

## MULTIPLUS 1



SA684.xx / SA687.xx

### **MANUALE DI ISTRUZIONE E INSTALLAZIONE** **INSTRUCTION AND INSTALLATION MANUAL**

Quadro elettronico avviamento diretto 1 motore per acque pulite e reflue con display e sezionatore blocca porta.

*Direct starting electronic control panel 1 motor for clean water and sewage with display and general disconnecting switch with door lock.*

1. Istruzioni generali per l'installazione.....	3
2. Avvertenze.....	3
3. Esempi applicativi.....	4-5
4. Schemi di collegamento	
4.1 Schema di collegamento SA684.xx.....	6
4.2 Schema di collegamento SA687.xx.....	7
5. Programmazione	
5.1 Programmazione rapida.....	8
5.2 Applicazione $\cos\phi$ .....	9
5.3 Applicazione 4-20mA bar .....	10
5.4 Applicazione 4-20mA metri.....	11
5.5 Programmazione avanzata.....	12-13
6. Funzionamento generale del quadro	
6.1 Funzionamento generale.....	14
6.2 Applicazione $\cos\phi$ .....	14
6.3 Applicazione acque pulite.....	15
6.4 Applicazione acque reflue.....	15
6.5 Applicazione 4-20mA bar.....	16
6.6 Applicazione 4-20mA metri.....	16
7. Ricerca guasti e soluzioni proposte.....	17
8. Data logger	
8.1 Data logger allarmi.....	18
8.2 Data logger eventi.....	18
9. Messaggi di allarme.....	19
10. Smaltimento di vecchi apparecchi elettrici ed elettronici.....	38
11. Dichiarazione di conformità.....	38

Assicurarsi che la linea sia protetta, secondo le normative, in funzione dell'applicazione. Accertarsi che la potenza e la corrente di targa del motore rispecchino i limiti di impiego del quadro.

Installare il quadro in ambienti adatti al suo grado di protezione IP65. Per il fissaggio dell'involucro, utilizzare le staffe per i box 03-04 e le apposite predisposizioni per i restanti box. Nell'effettuare il fissaggio dell'involucro fare molta attenzione a non toccare o danneggiare i vari componenti. Eliminare qualsiasi tipo di impurità metallica e/o plastica che dovesse casualmente cadere all'interno dell'involucro (viti, rondelle, polvere...). Effettuare i collegamenti elettrici rispettando gli schemi di collegamento.

Nel fissare i cavi sulle morsettiere, adoperare attrezzi di giuste misure e dimensioni evitando di danneggiare i morsetti metallici e le relative sedi. Prima di qualsiasi operazione da effettuare all'interno, escludere l'alimentazione generale.





Le operazioni di regolazione all'interno del quadro devono essere svolte da personale qualificato. In caso di intervento delle protezioni verificarne la causa prima del ripristino.

In caso di necessità sostituire i vari componenti solo con altri aventi le stesse caratteristiche e portate di quelli originali.

**È compito dell'installatore verificare l'apparecchiatura dopo l'installazione nonostante questa sia già stata sottoposta regolarmente a prove dal costruttore.**

**Il costruttore declina ogni responsabilità per sinistri a cose o persone dovuti a manomissioni delle apparecchiature da parte di personale non autorizzato o da carenze nella manutenzione e riparazione.**

## 2. AVVERTENZE

	<p><b>SCOSSE ELETTRICHE</b></p> <p>Rischio di scosse elettriche se non si osserva quanto prescritto.</p>
	<p><b>PERICOLO</b></p> <p>Rischio di lesioni personali e materiali se non si osserva quanto prescritto.</p>
	<p><b>AVVERTENZA</b></p> <p>Prima di installare e utilizzare questo prodotto leggere attentamente questo manuale nella sua totalità. L'installazione e la manutenzione devono essere realizzate da personale qualificato e secondo le normative in vigore. Il costruttore non è responsabile di danni causati per un uso improprio o proibito di questo dispositivo e nemmeno di danni causati da una non corretta installazione e manutenzione dello stesso. L'utilizzo di pezzi non originali, la manipolazione o l'uso improprio annulleranno la garanzia.</p>
	<p><b>AVVERTENZA</b></p> <p>Assicurarsi che la potenza del motore sia dentro i limiti del quadro. Installare il dispositivo solo in ambienti adeguati al suo grado di protezione IP 65. Nel caso di operazioni dentro il quadro utilizzare strumenti adeguati per evitare di danneggiare i morsetti.</p>
	<p><b>PERICOLO</b></p> <p>Prima di realizzare qualsiasi intervento assicurarsi che il quadro non sia alimentato. Non compiere nessuna operazione quando il quadro è aperto. Il dispositivo deve essere collegato a una messa a terra efficiente. Per fissare la carcassa utilizzare i fori appropriati presenti nel fondo per non danneggiare i componenti interni e eliminare qualsiasi scarto di lavoro dentro il quadro. Nel caso di intervento delle protezioni verificarne la causa prima del ripristino.</p>

### 3. ESEMPI APPLICATIVI

Di seguito vengono illustrati alcuni esempi pratici delle applicazioni che è possibile realizzare con il quadro **MULTIPLUS 1**.

**MARCIA A SECCO COS $\phi$  (1 INGRESSO)**

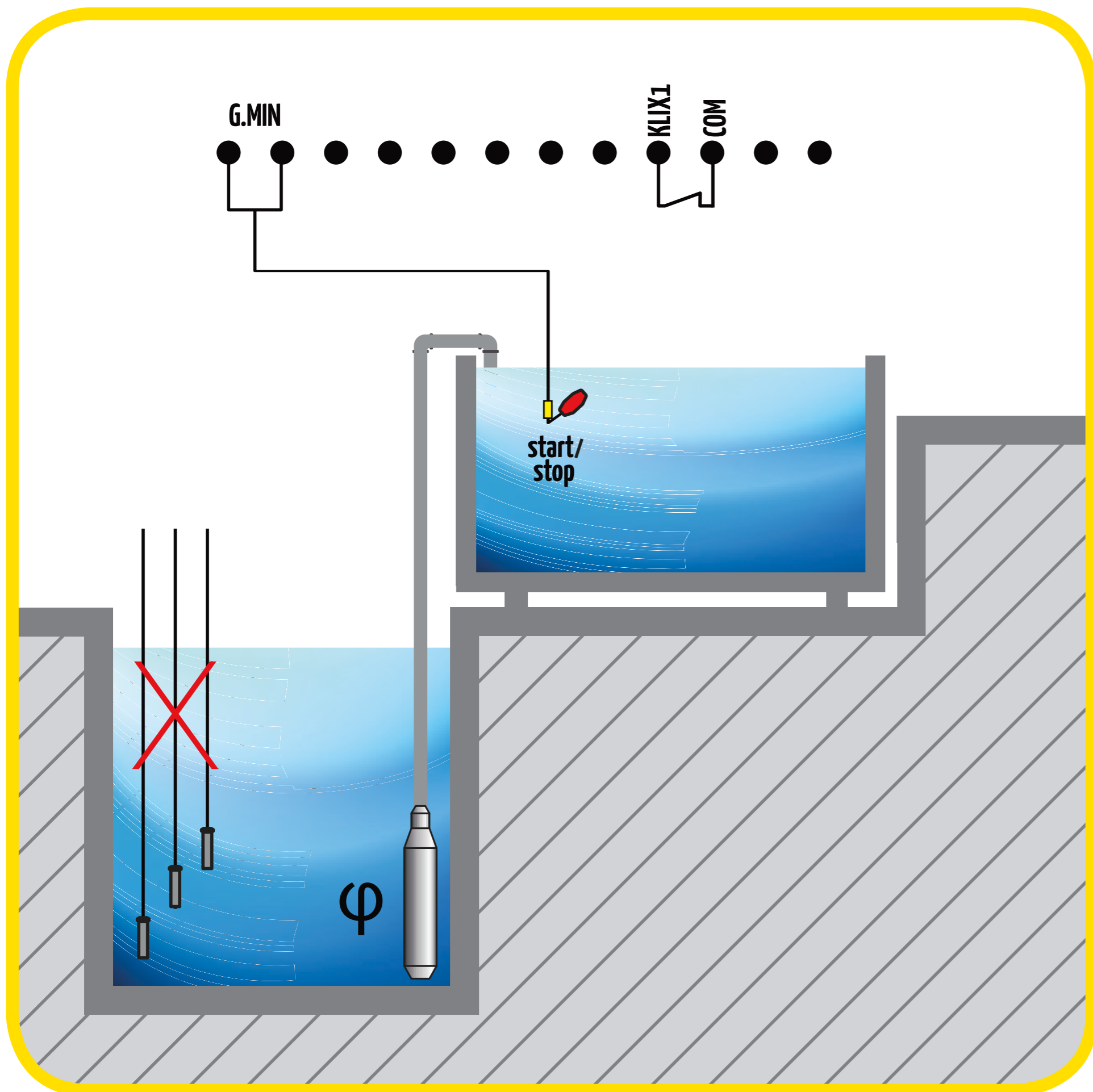

**MARCIA A SECCO COS $\phi$  (2 INGRESSI)**

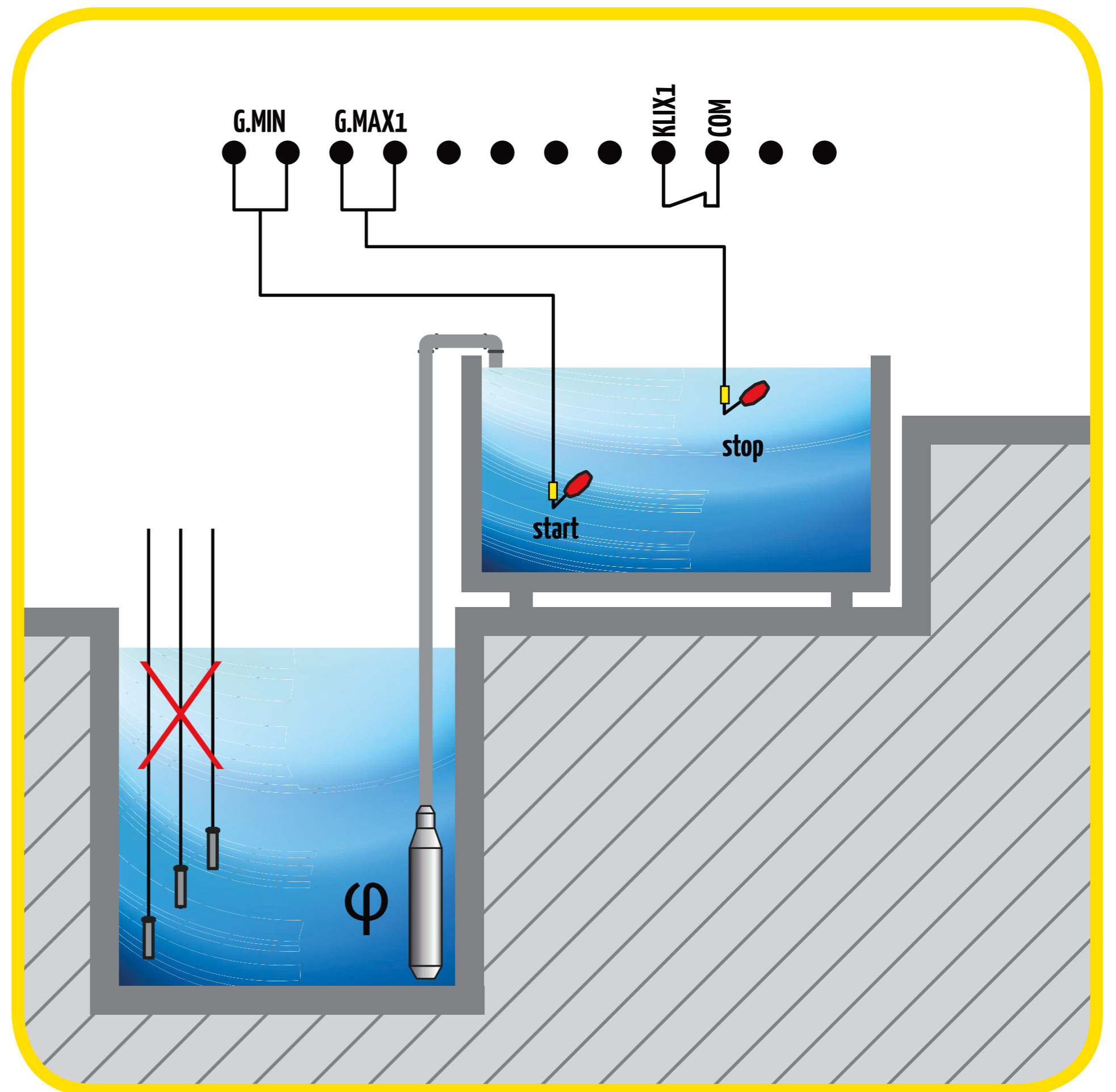

**ACQUE PULITE (RILANCIO)**

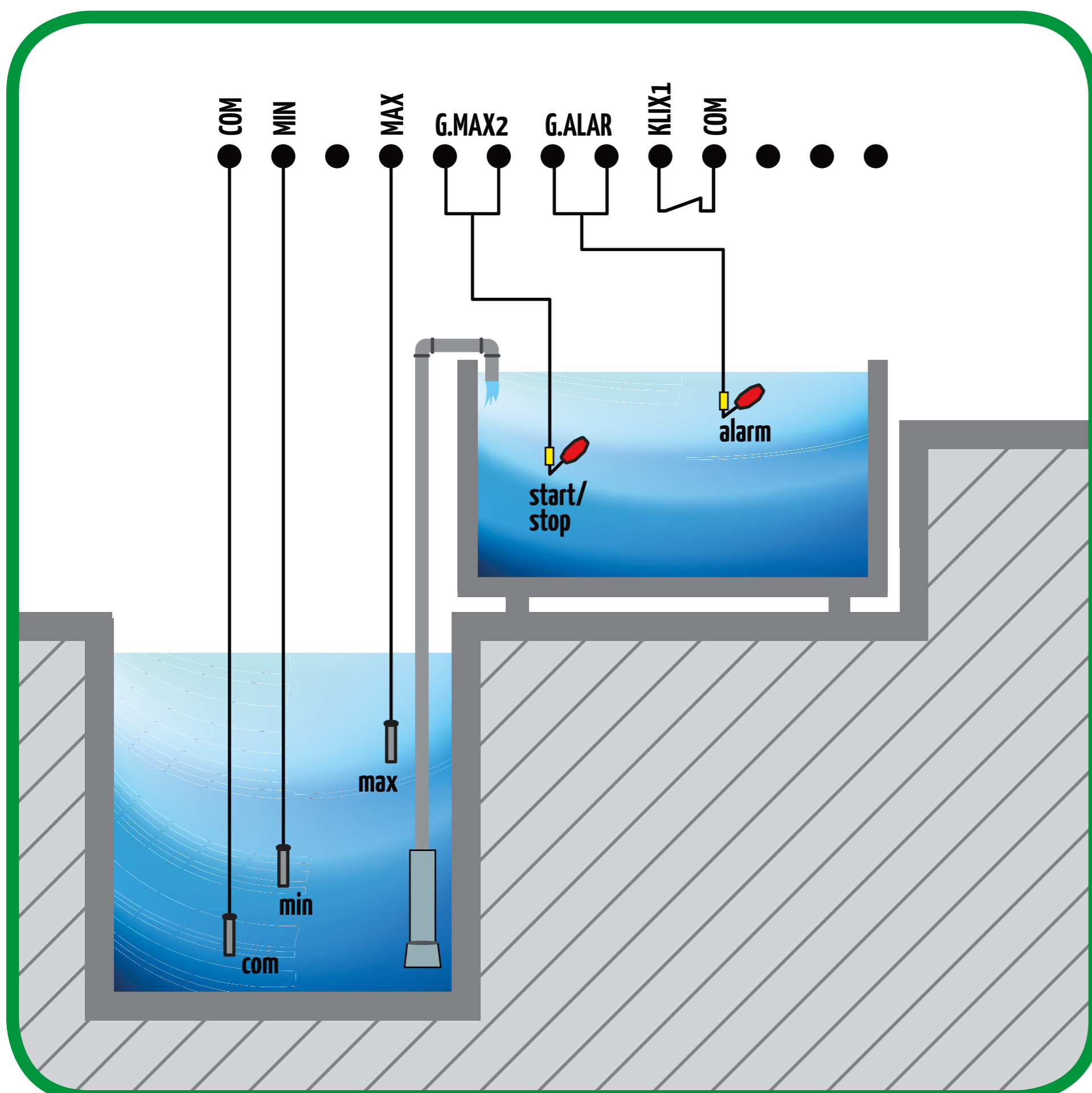

**ACQUE PULITE (SVUOTAMENTO)**

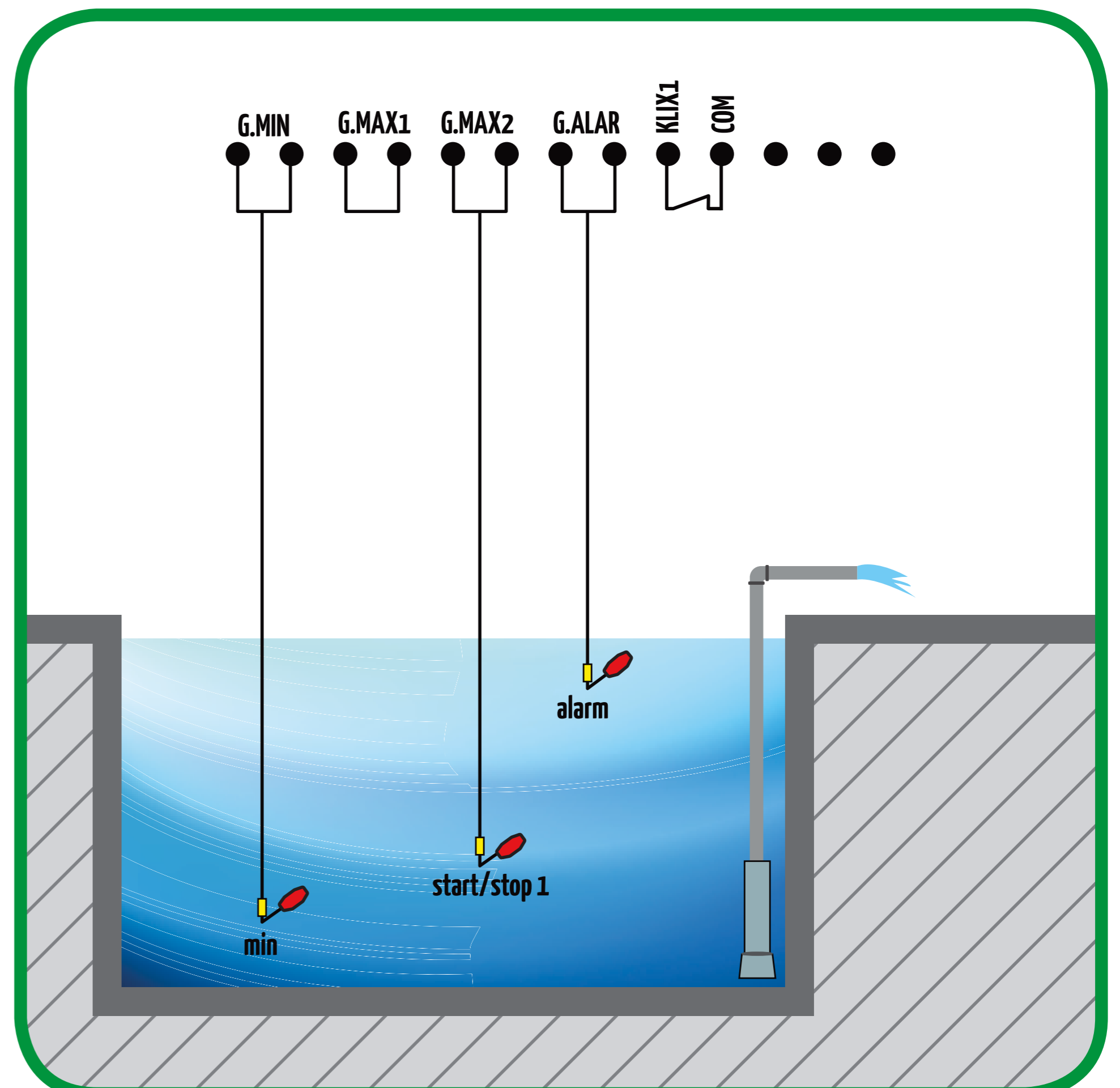

**LEGENDA COMPONENTI**

 Galleggiante per acque pulite

 Sonda di livello

Di seguito vengono illustrati alcuni esempi pratici delle applicazioni che è possibile realizzare con il quadro **MULTIPLUS 1**.

ACQUE REFLUE

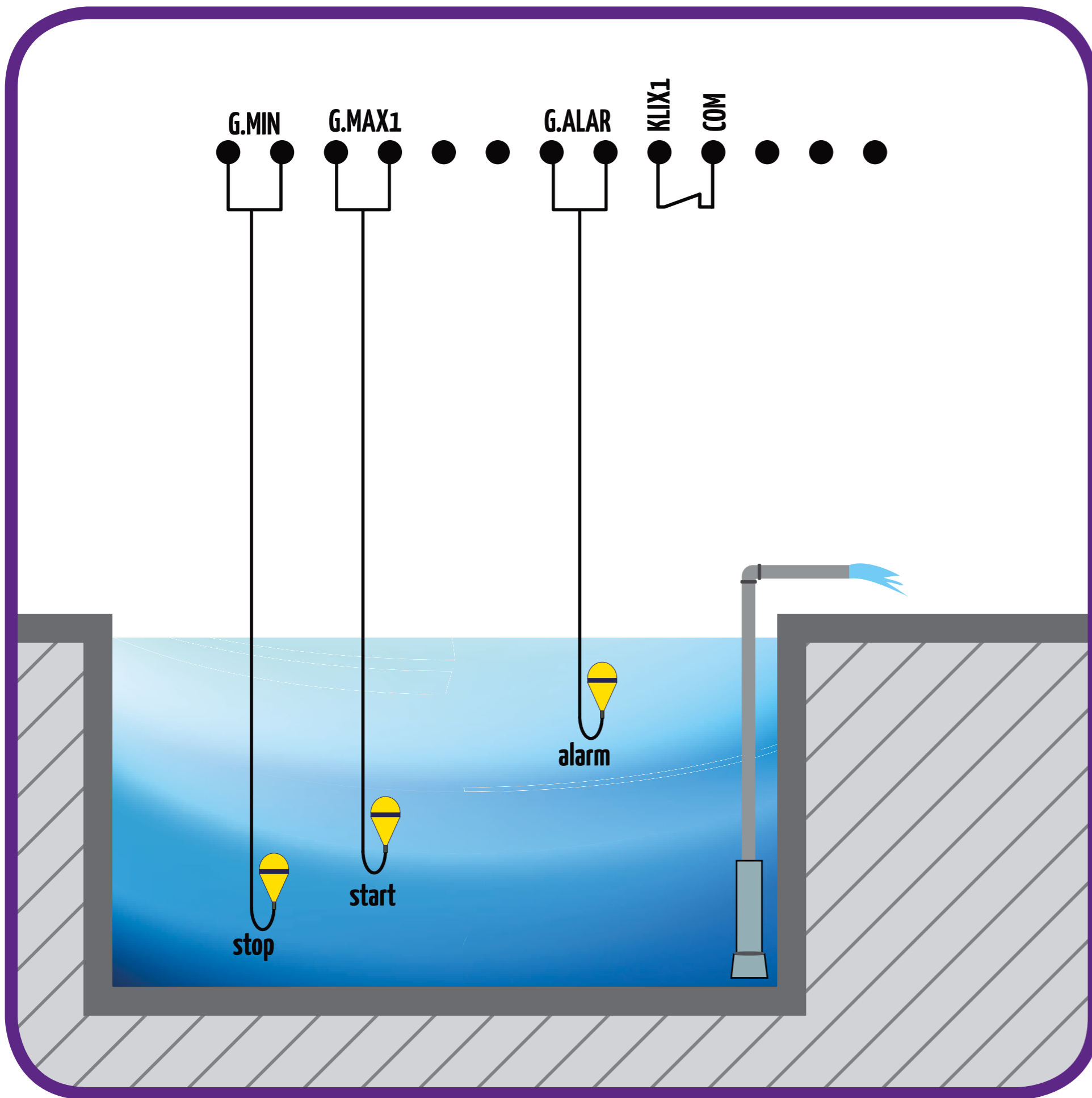

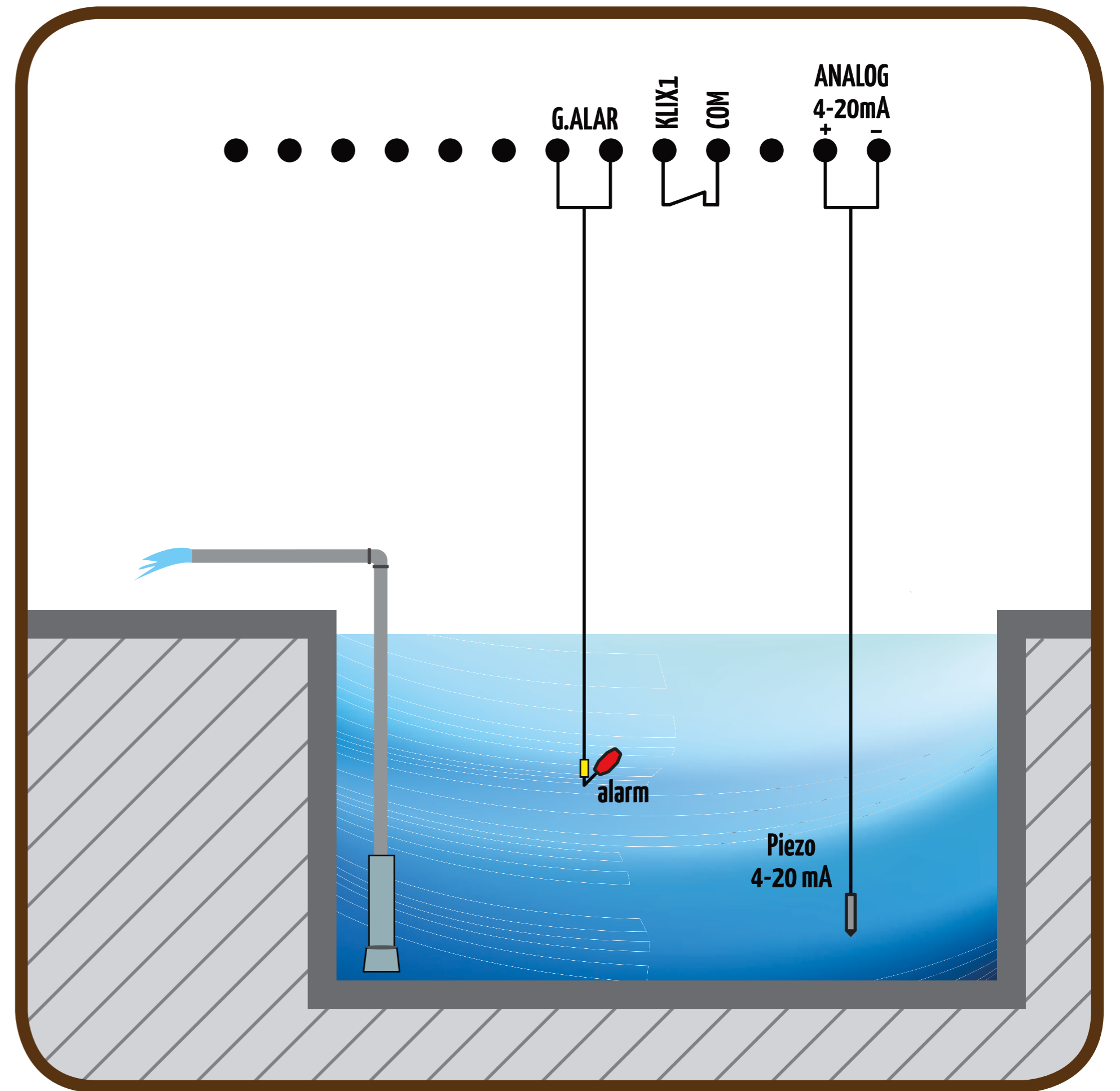

4-20mA metri



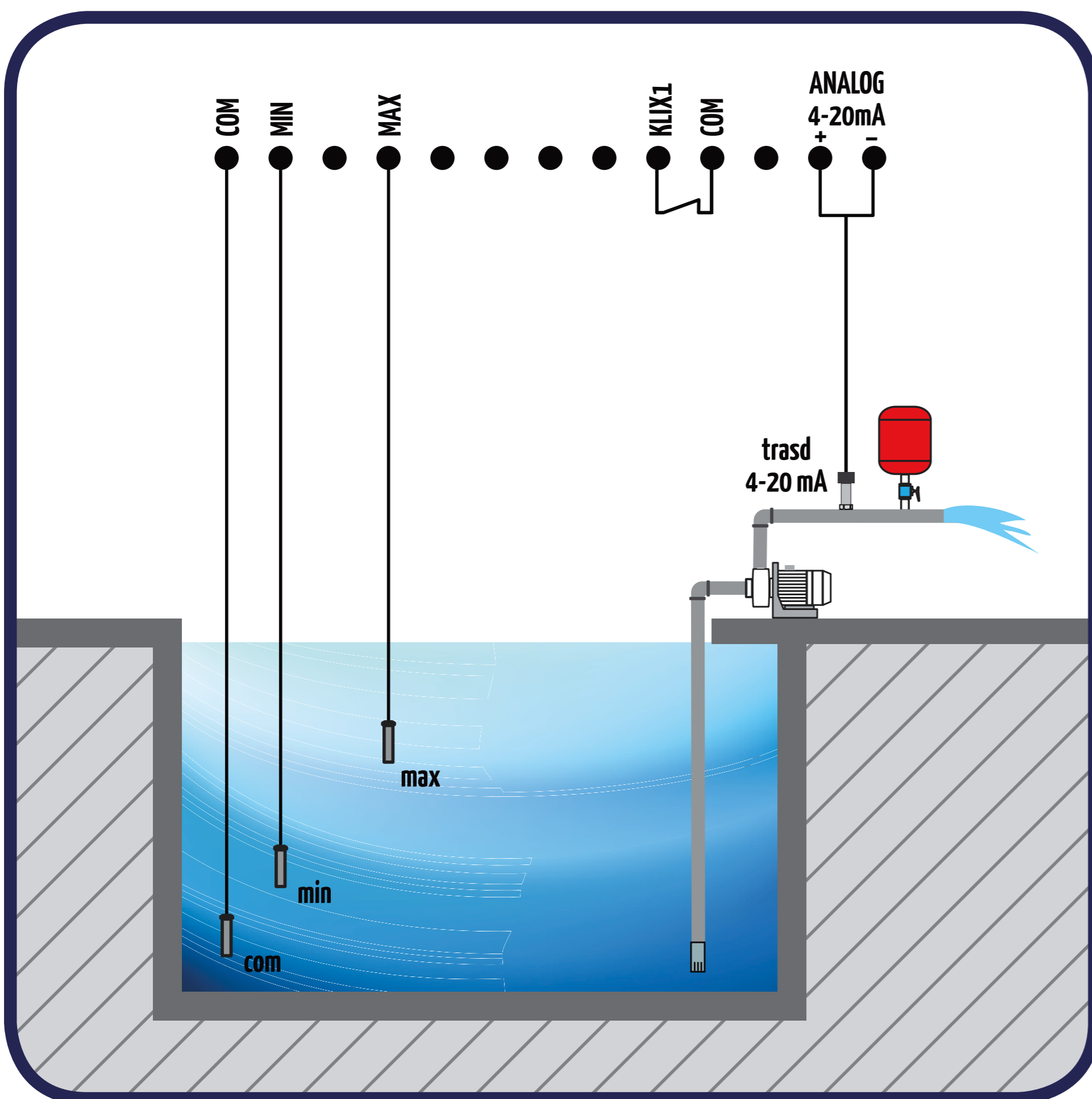

4-20mA bar

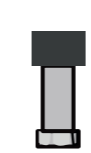

LEGENDA COMPONENTI

-  Galleggiante per acque pulite
-  Galleggiante per acque reflue
-  Sonda di livello

-  Trasduttore di pressione 4-20mA
-  Sonda piezoresistiva 4-20mA

## 4. SCHEMI DI COLLEGAMENTO

### 4.1 Schema di collegamento SA684.xx

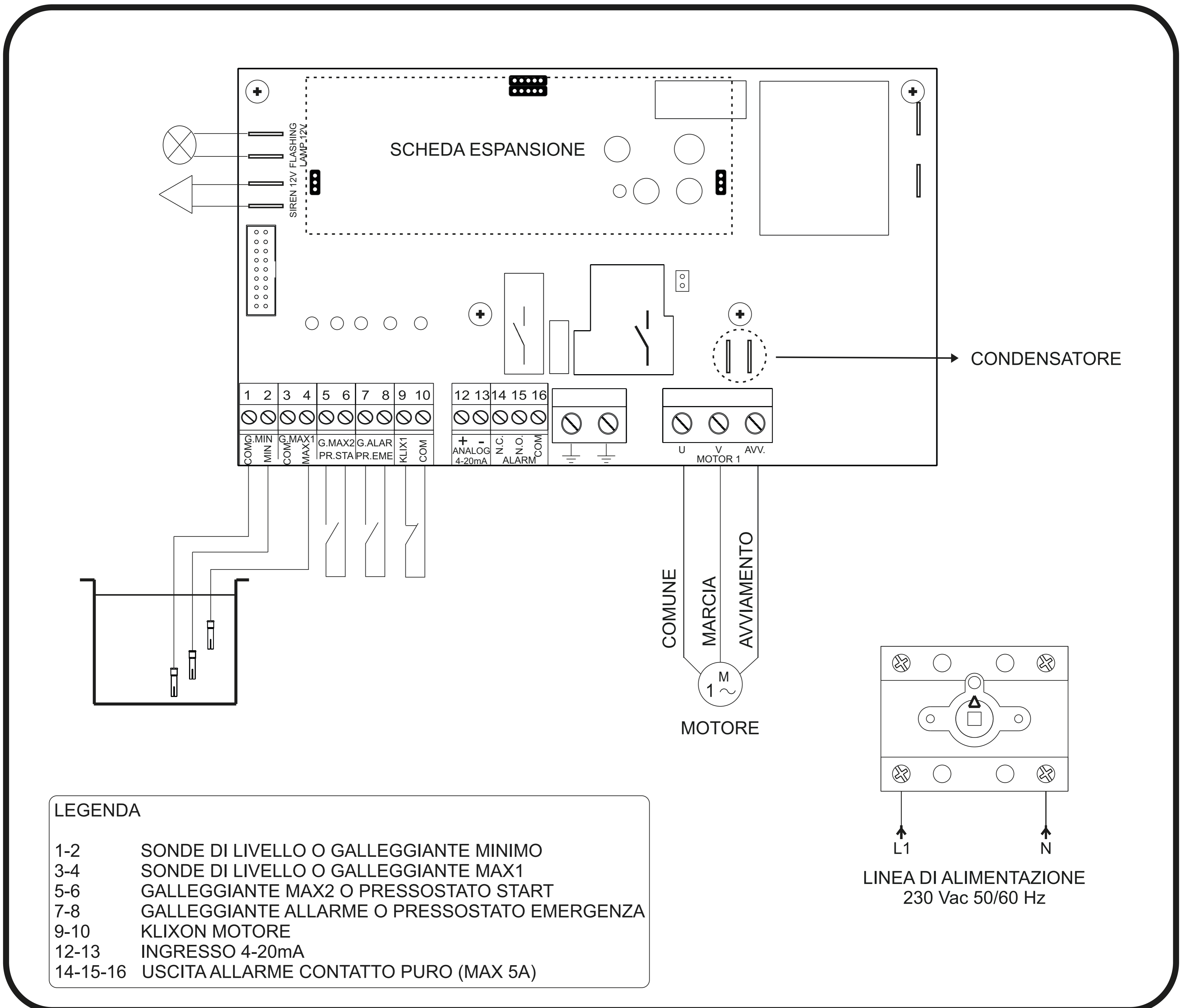

COLLEGAMENTO TRASDUTTORE DI PRESSIONE

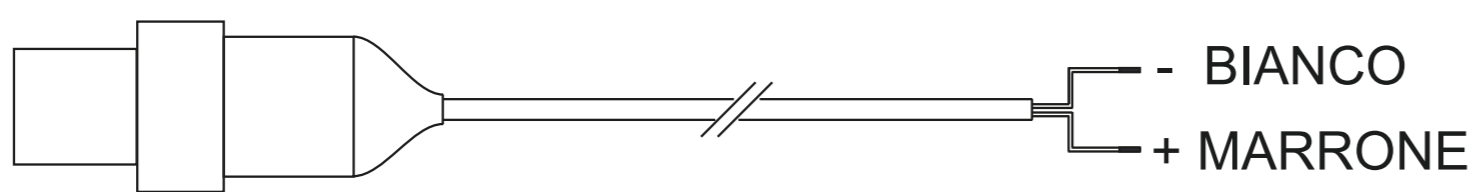

COLLEGAMENTO TRASMETTITORE DI LIVELLO PIEZORESISTIVO 4-20mA

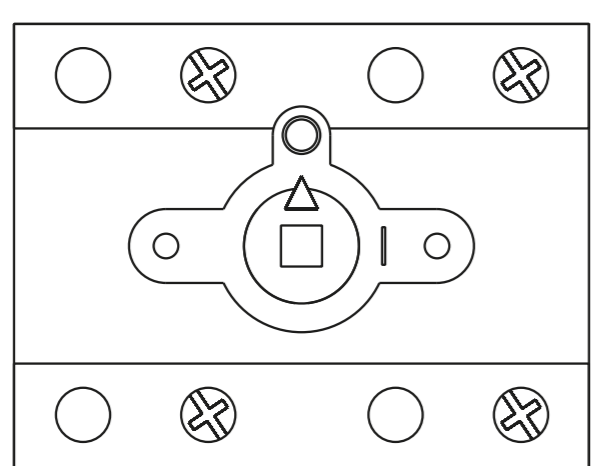
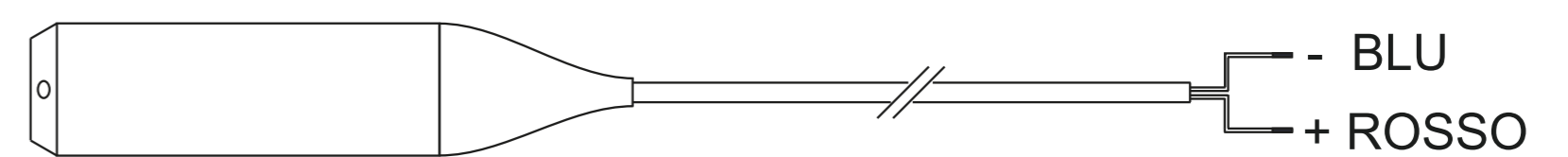

Max 10 mm<sup>2</sup>  
⊕ (M4)  
0,8Nm

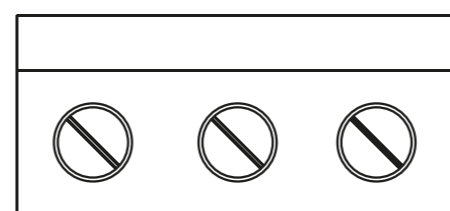

Max 4 mm<sup>2</sup>  
⊕ (M3)  
0,5Nm

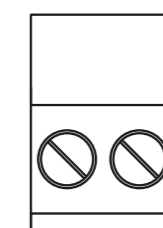

Max 2.5 mm<sup>2</sup>  
⊖ (M3)  
0,5Nm

4.2 Schema di collegamento SA687.xx

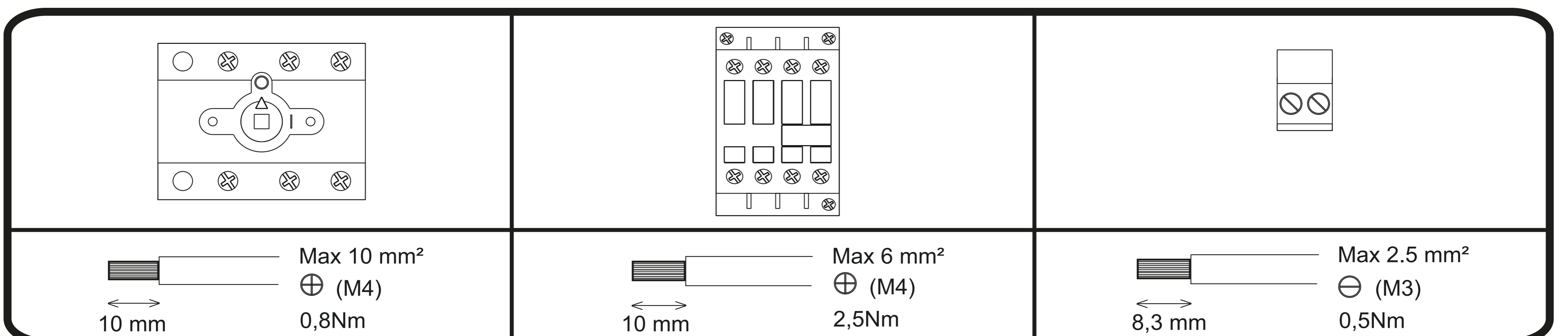
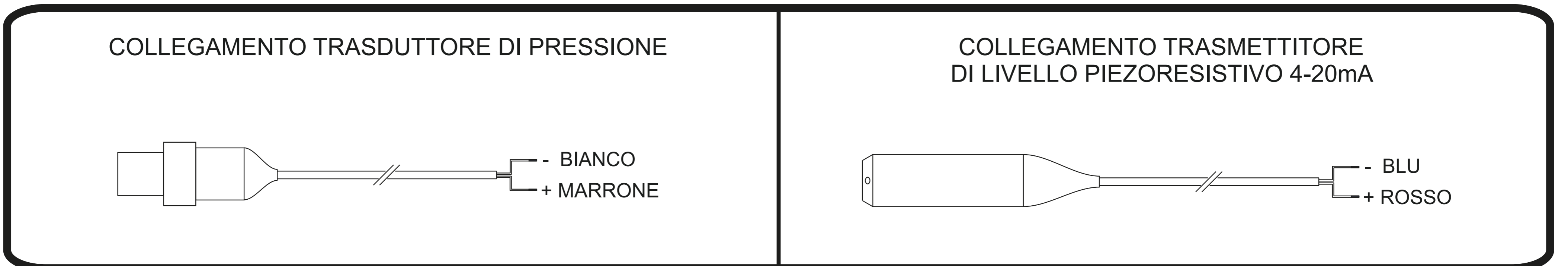
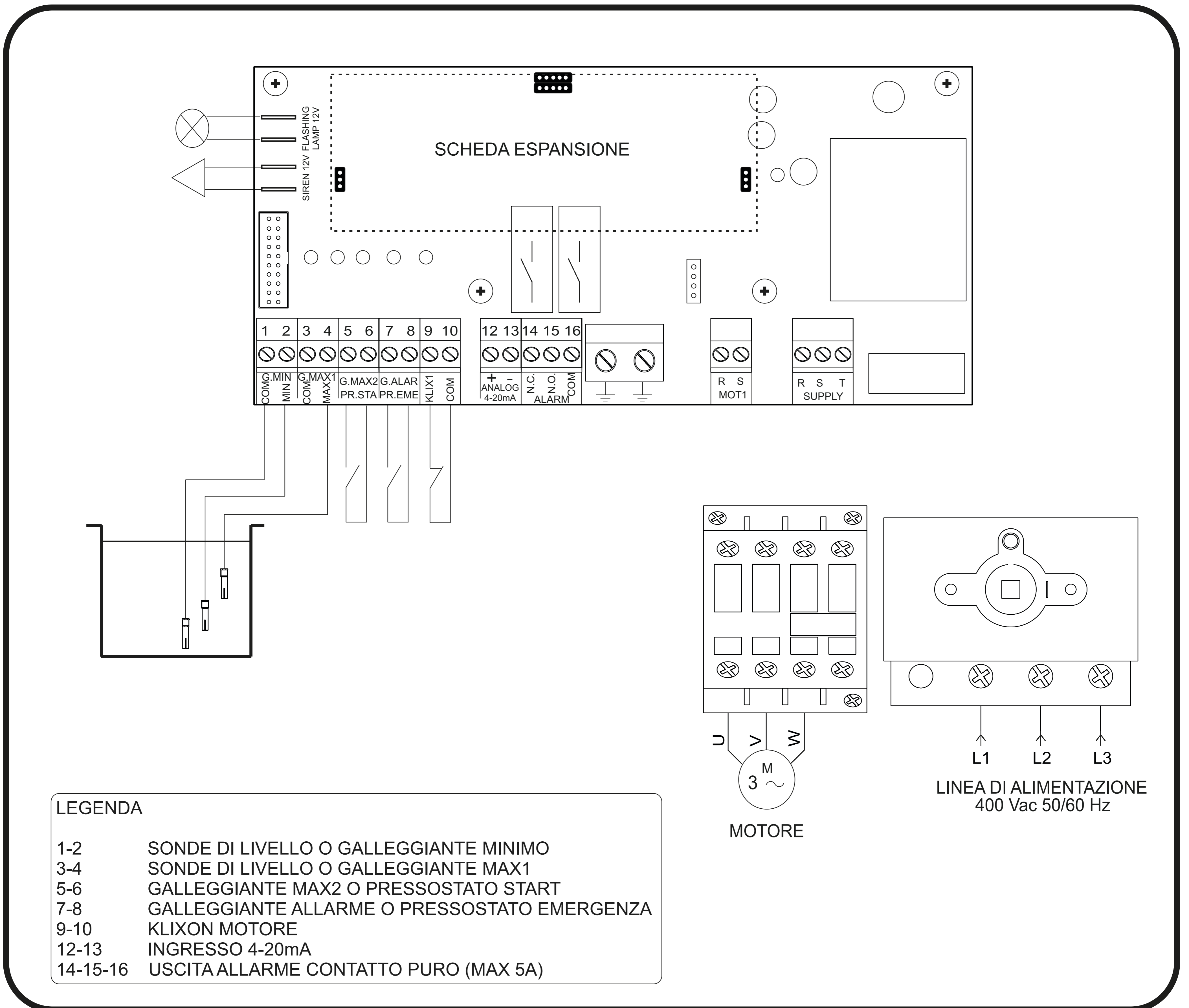

# 5. PROGRAMMAZIONE

## 5.1 Programmazione rapida ☆

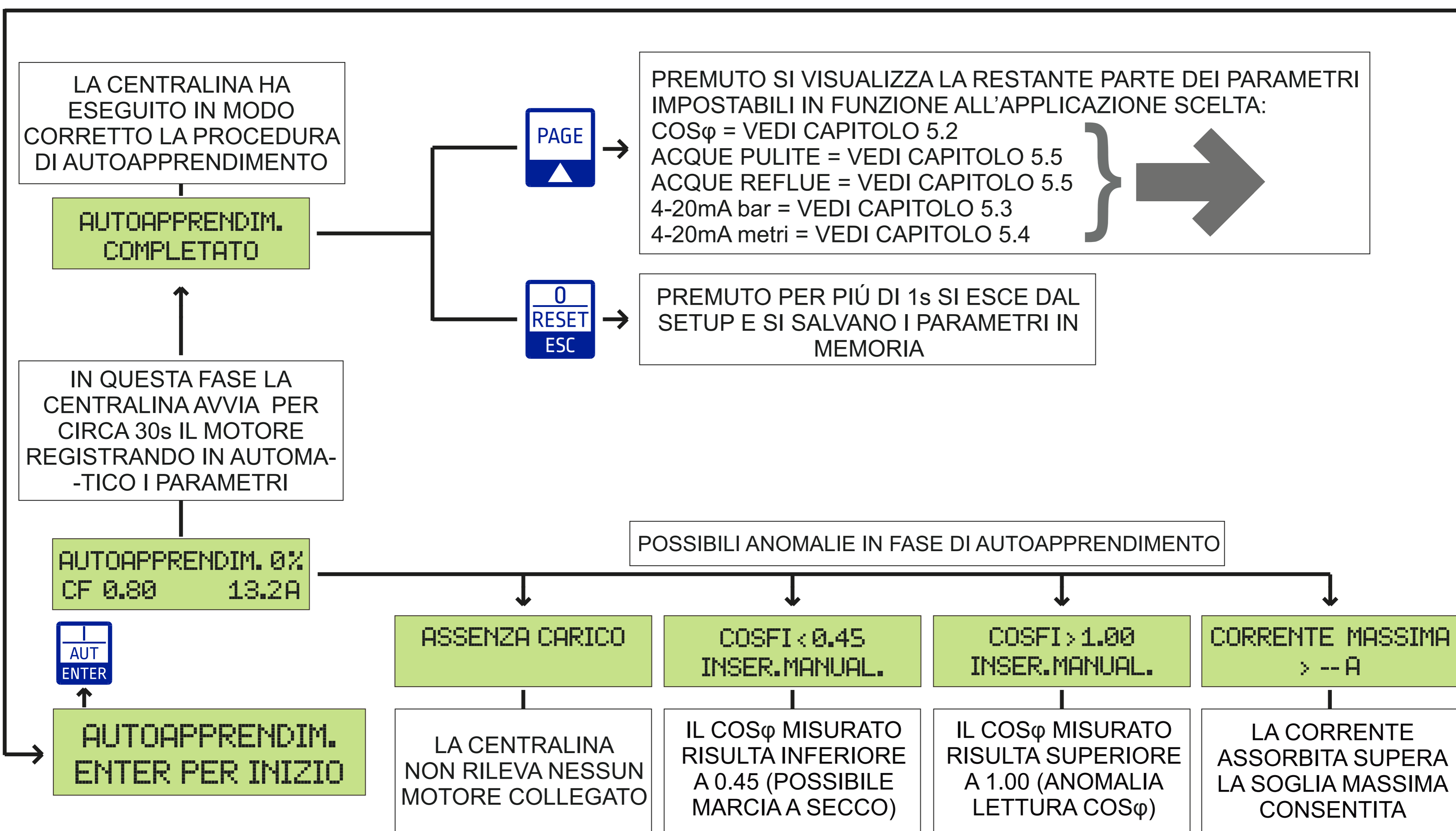
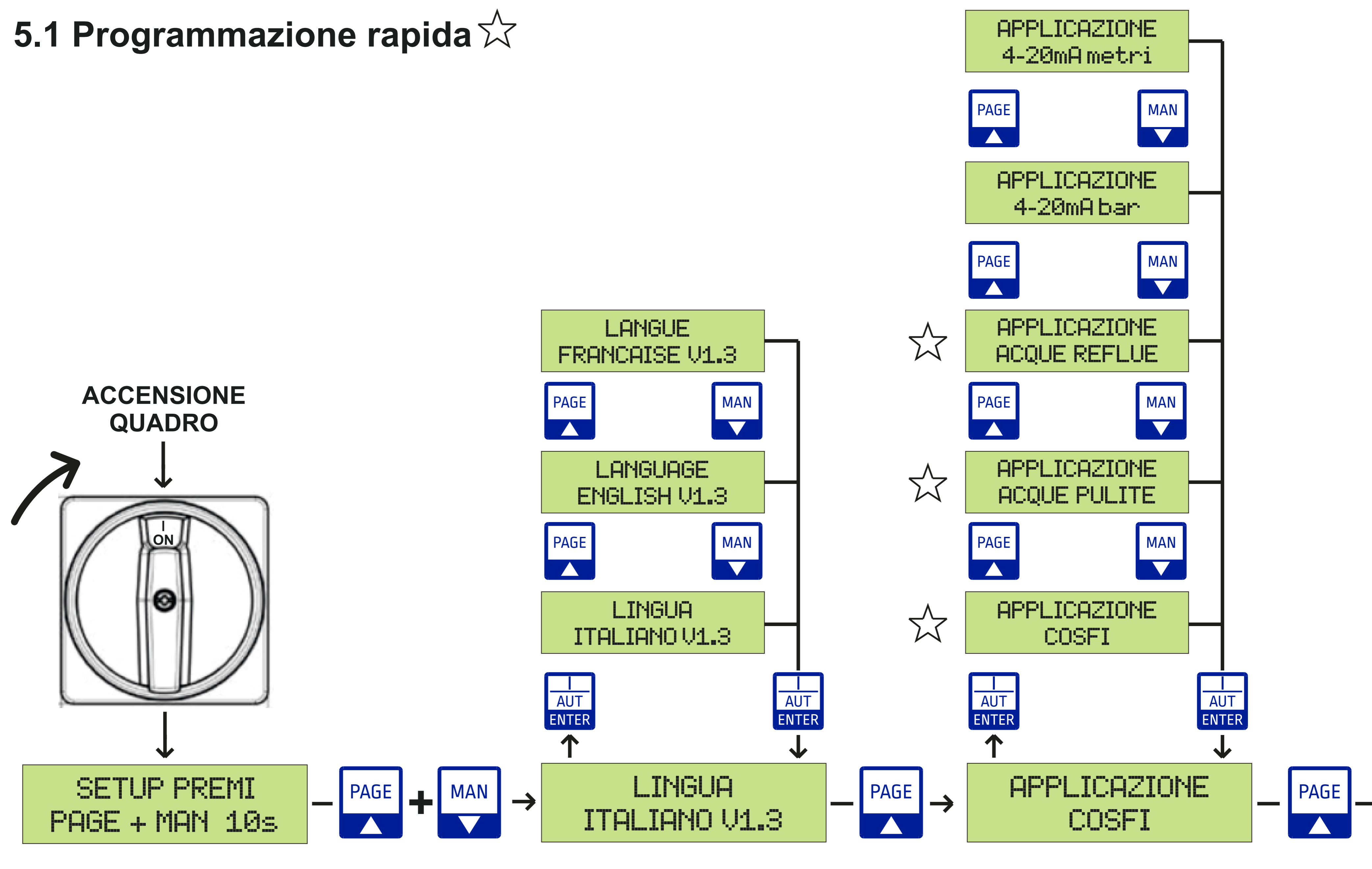

	Premuto esce dal parametro		Premuto permette di entrare nel parametro selezionato Premuto conferma il valore impostato
	Serve a scorrere avanti le pagine del setup Serve ad aumentare il valore di un parametro		Serve a scorrere indietro le pagine del setup Serve a ridurre il valore di un parametro



5.2 Applicazione cosφ

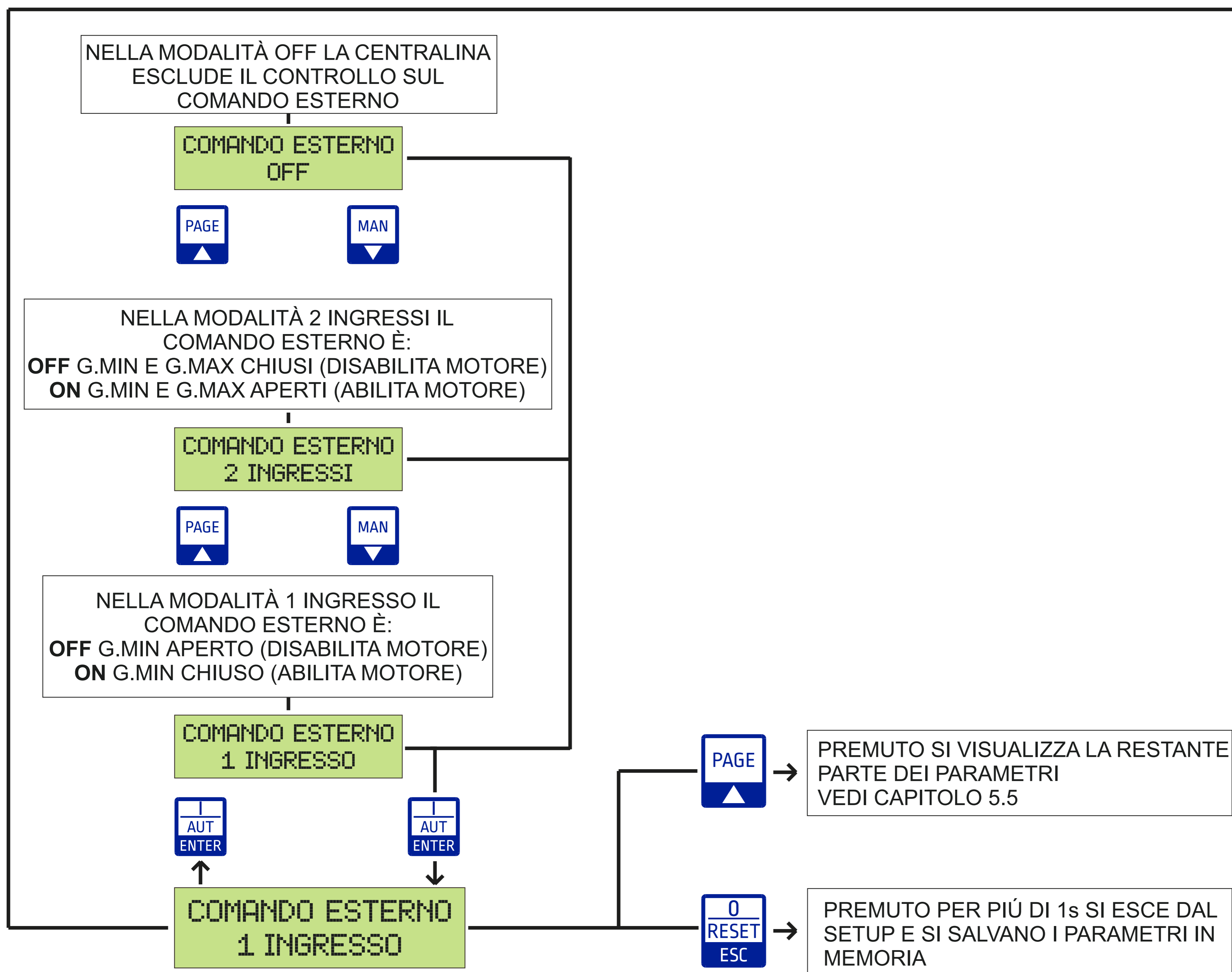
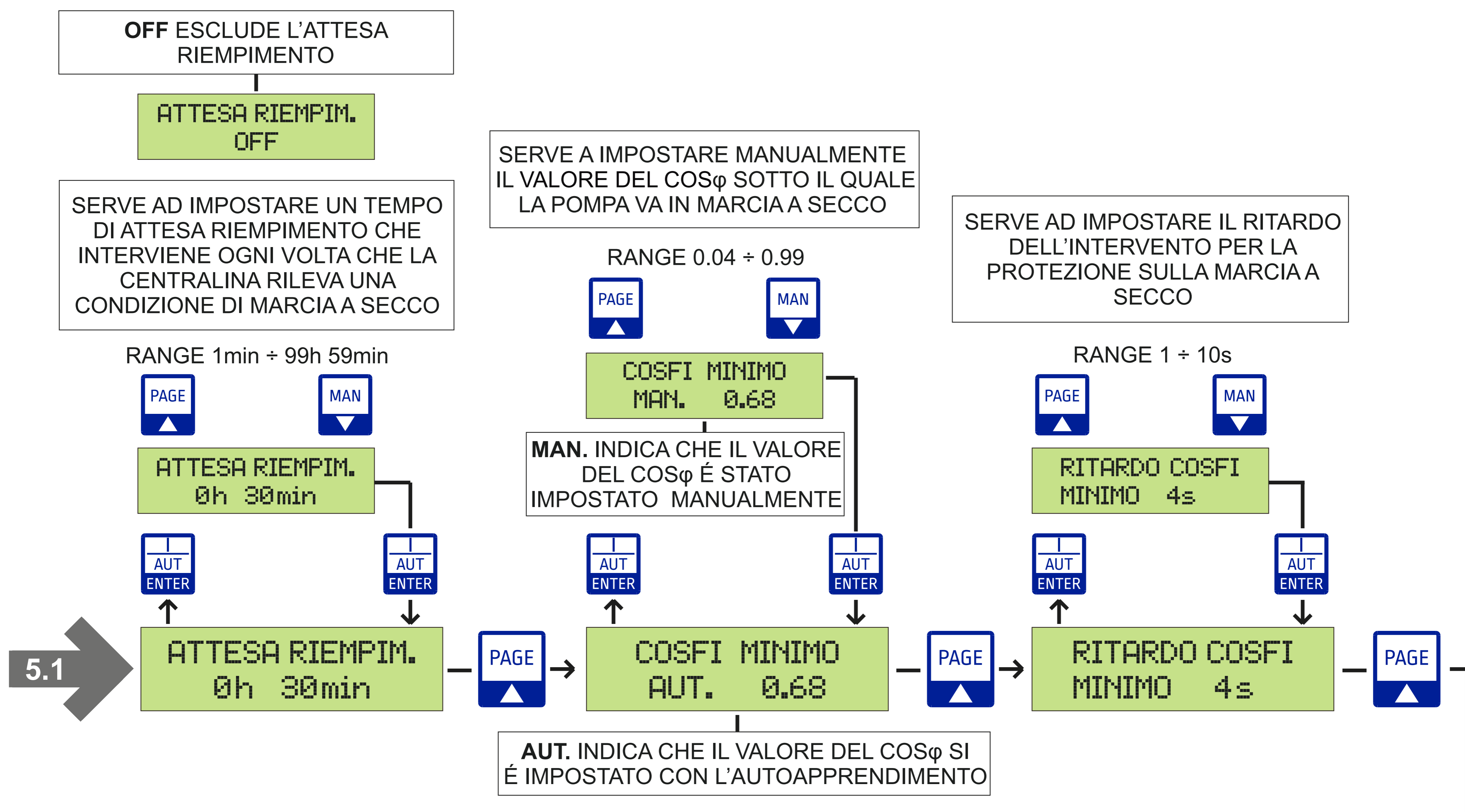

## 5.3 Applicazione 4-20mA bar

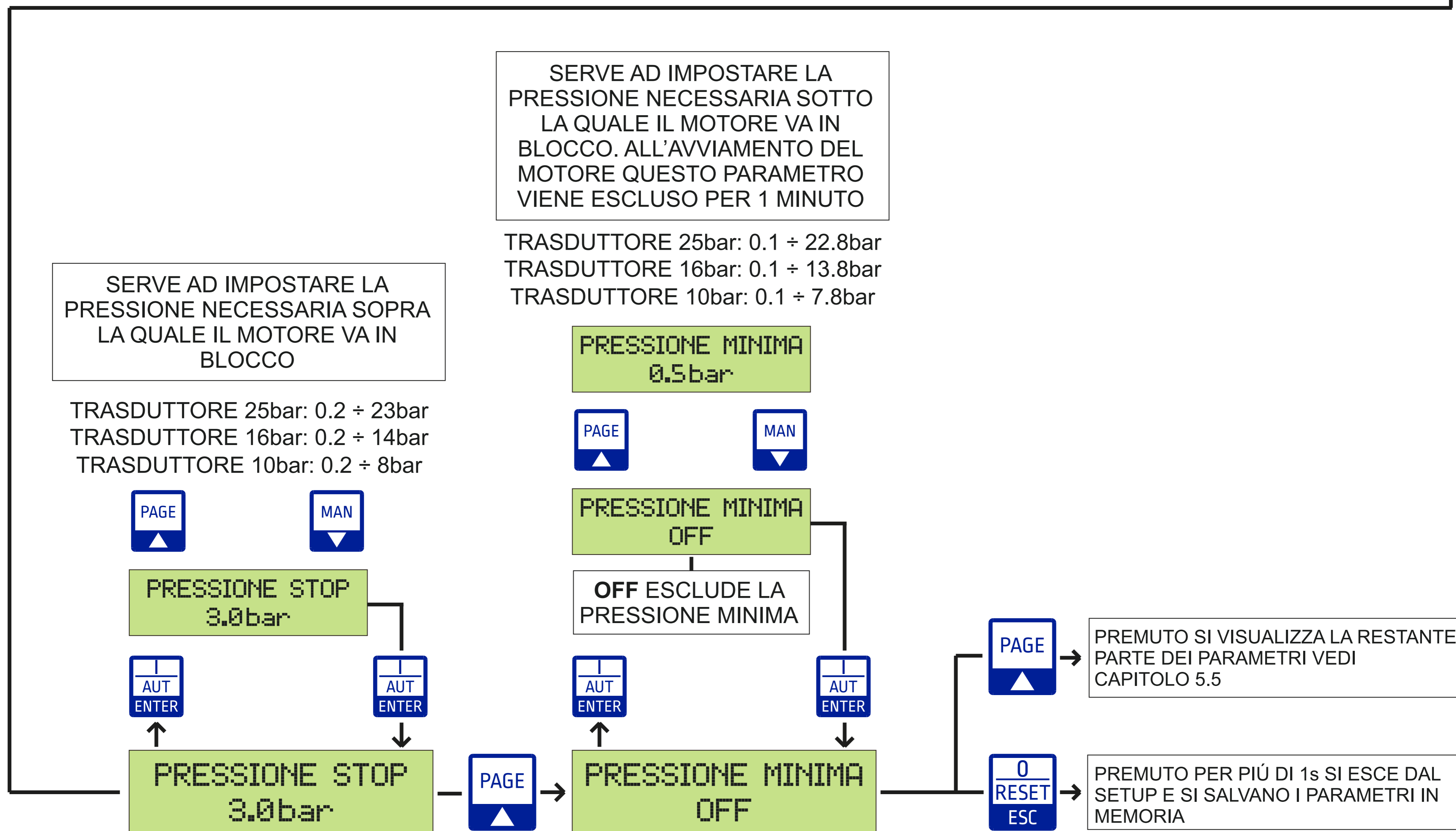
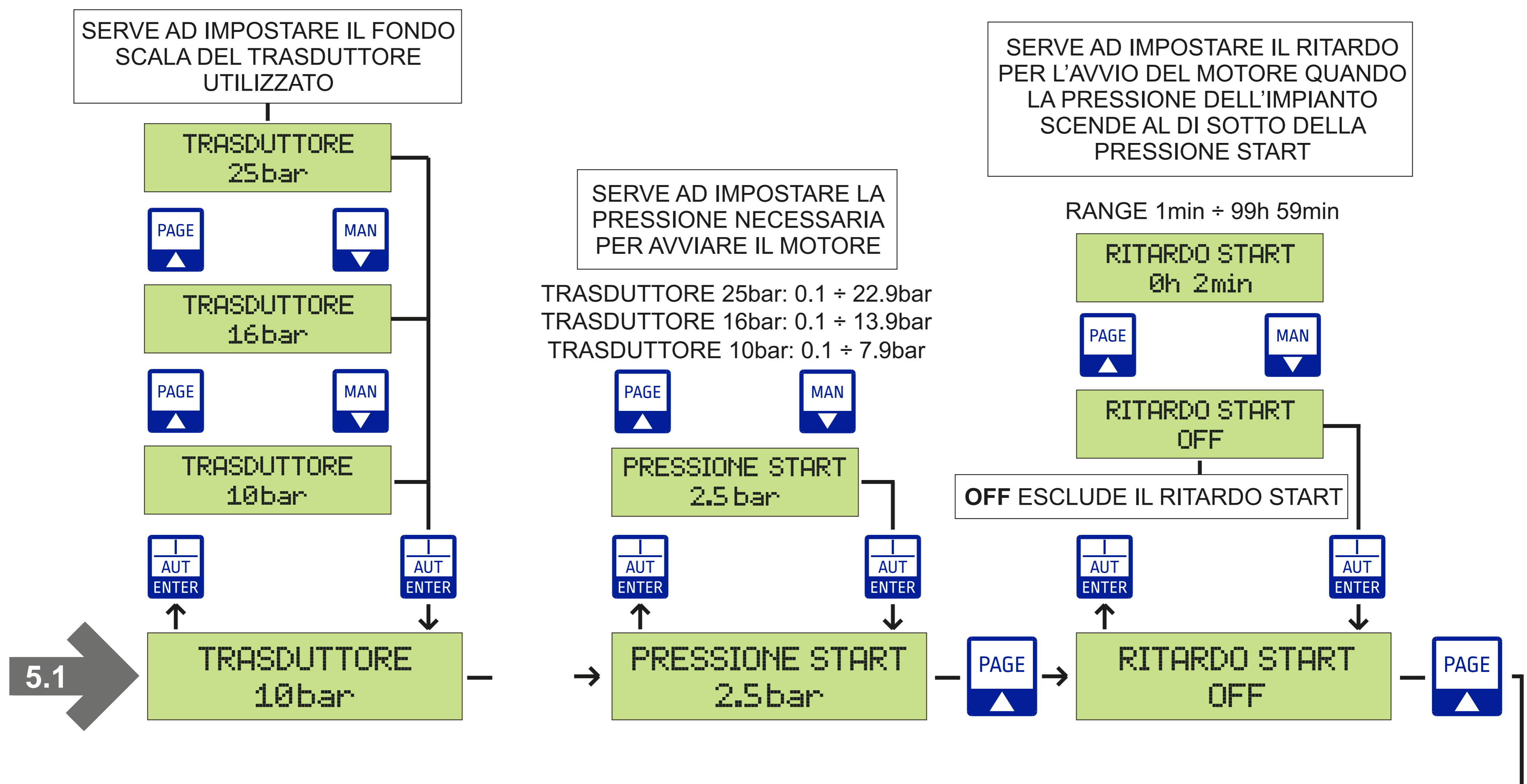

5.4 Applicazione 4-20mA metri

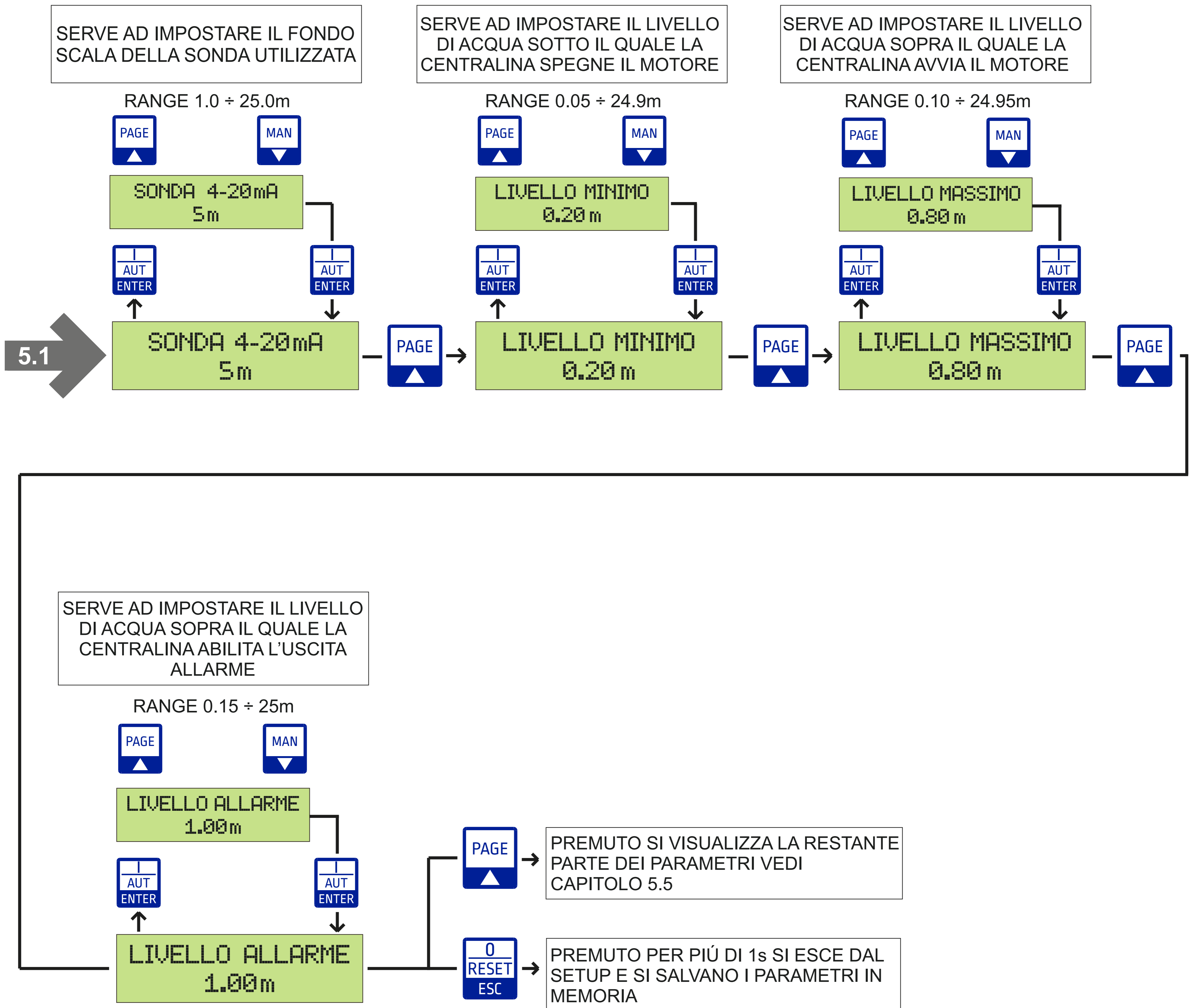

## 5. PROGRAMMAZIONE

### 5.5 Programmazione avanzata

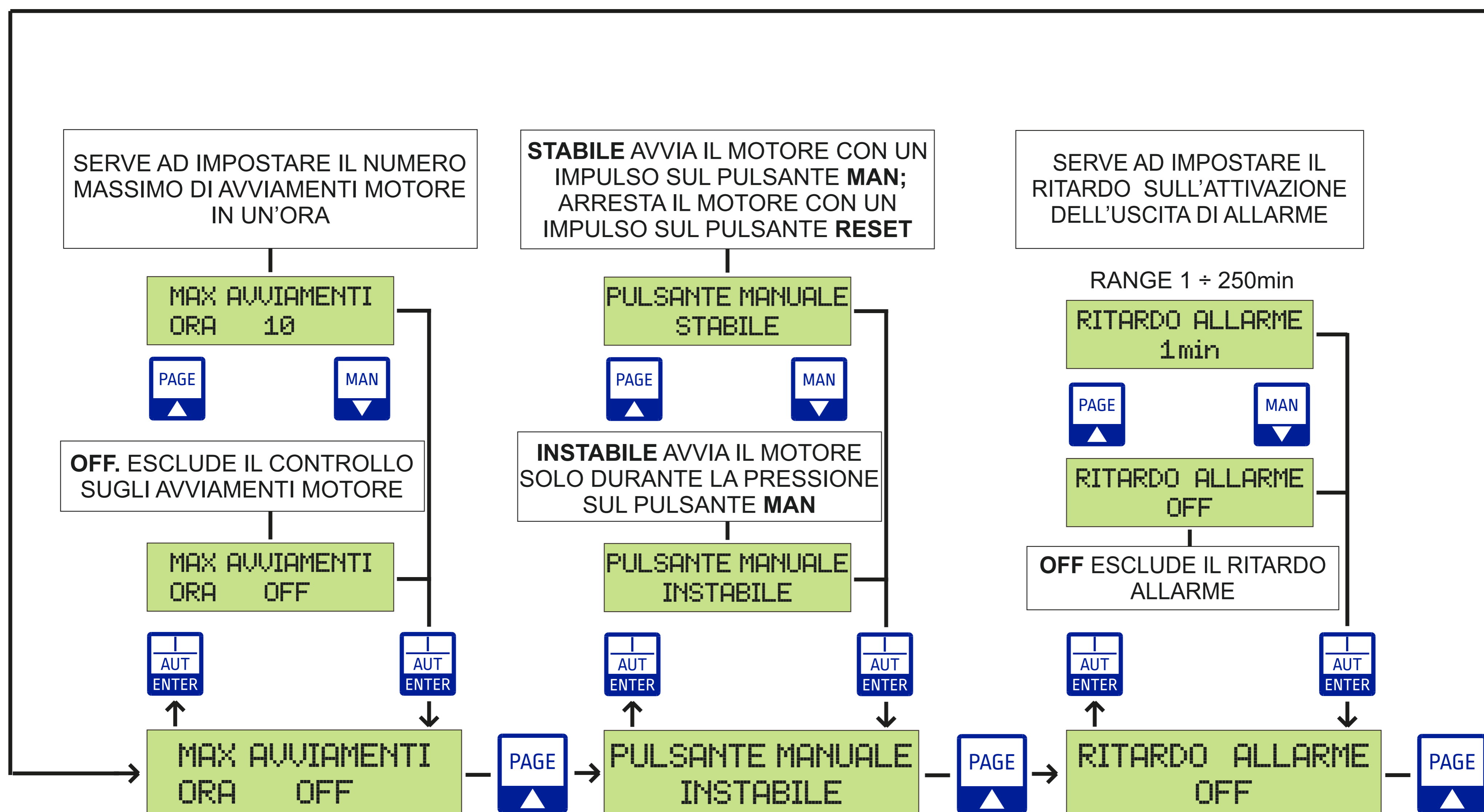
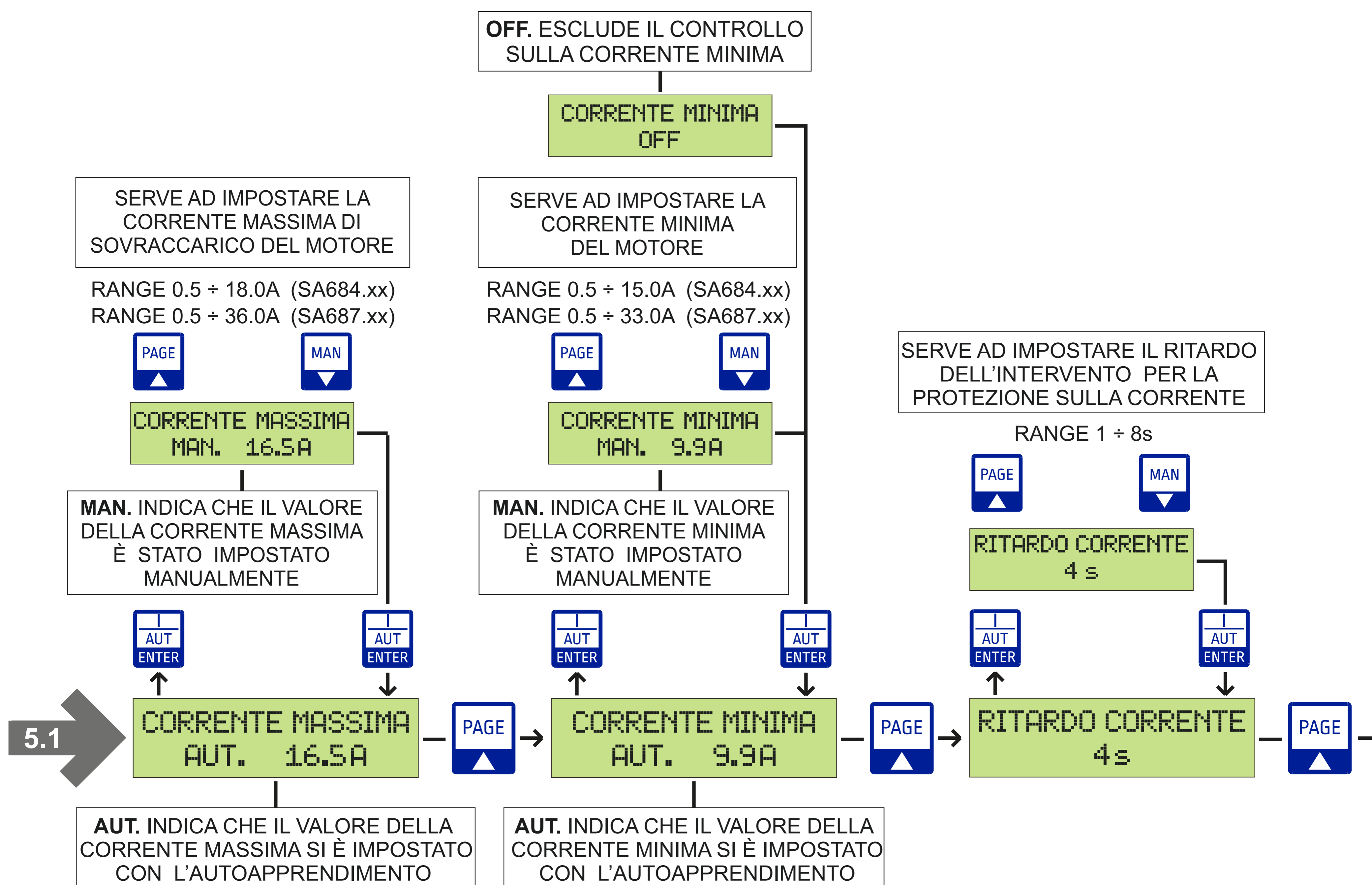

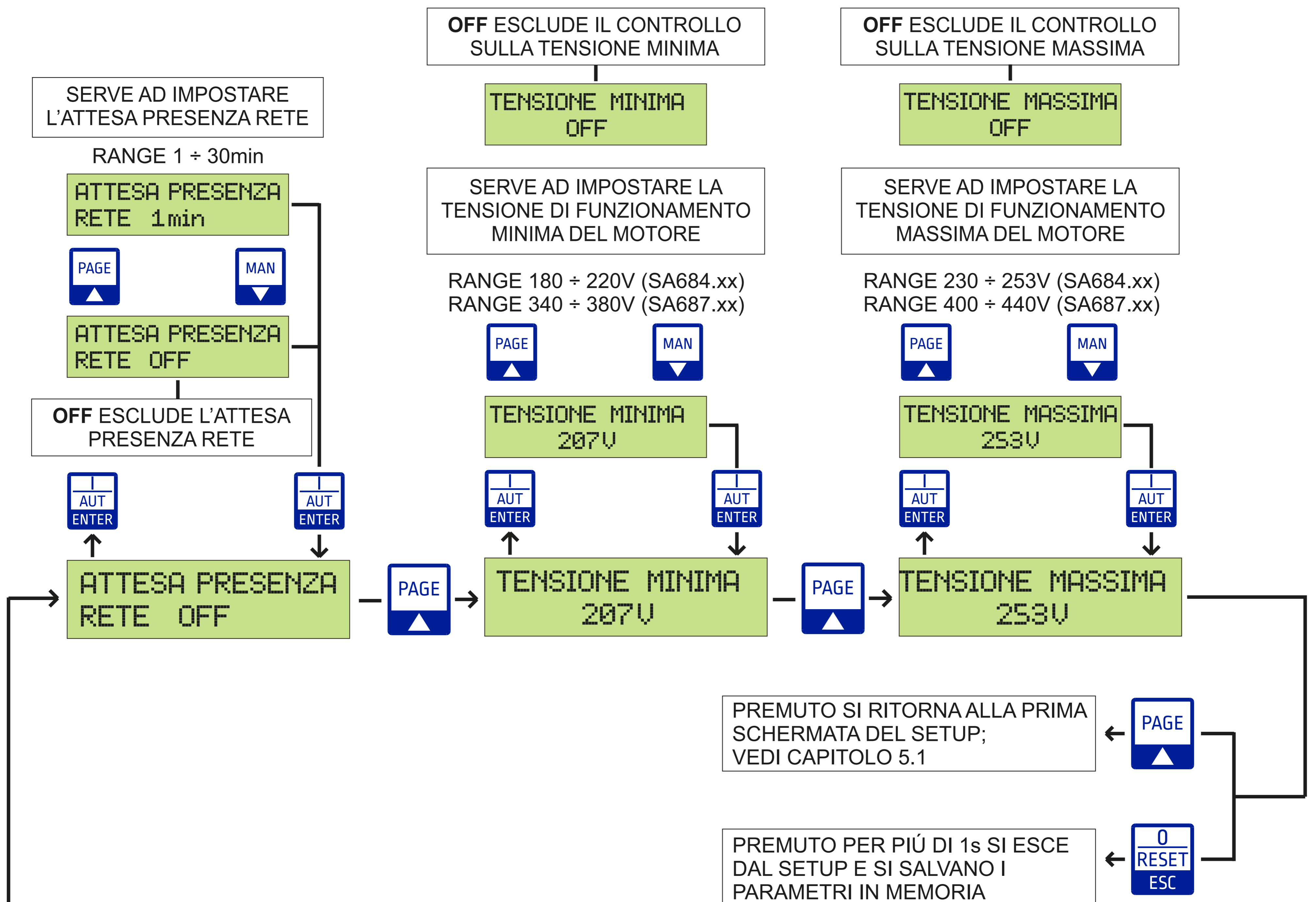



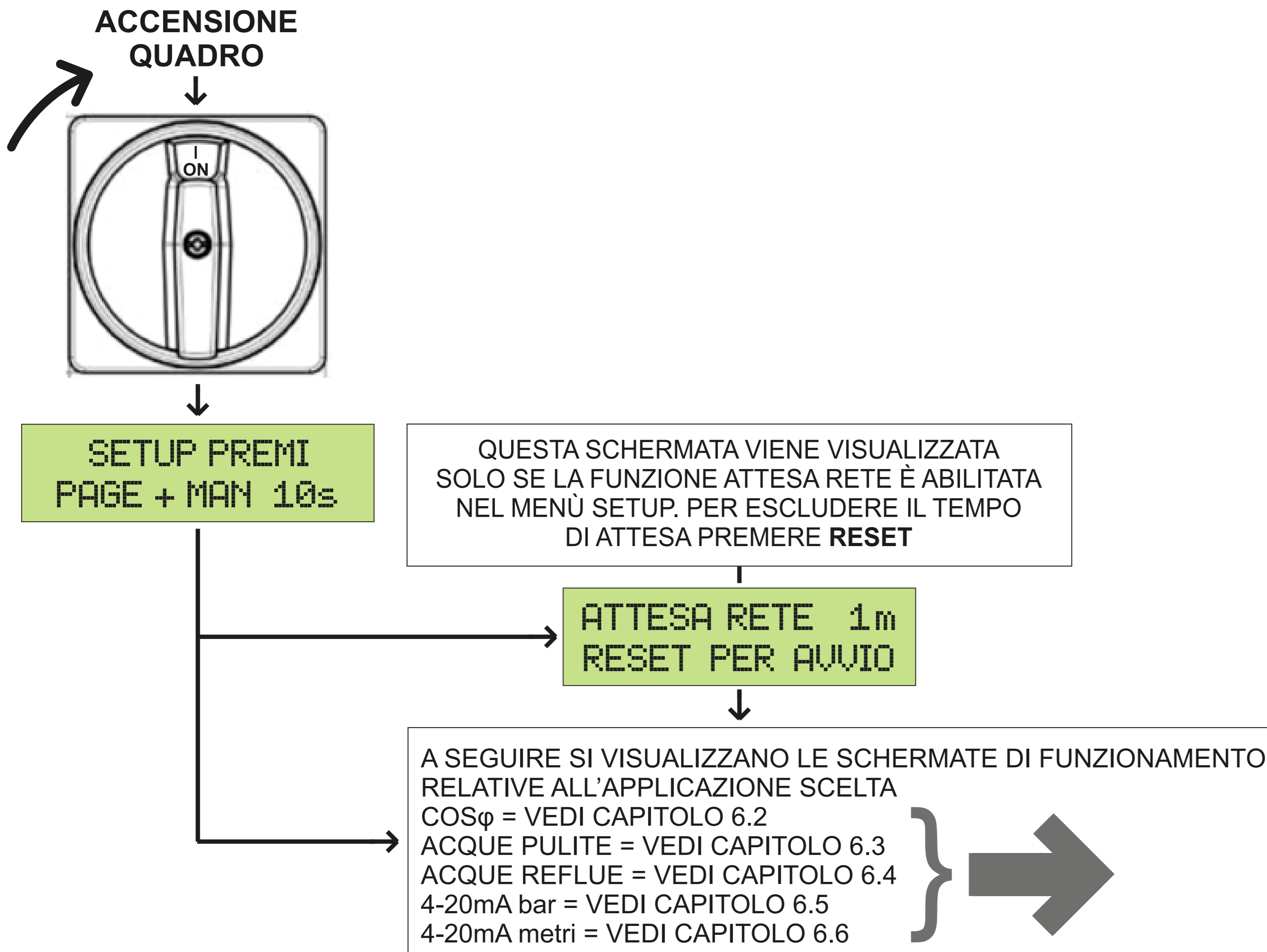

## 6. FUNZIONAMENTO GENERALE DEL QUADRO

### 6.1 Funzionamento generale

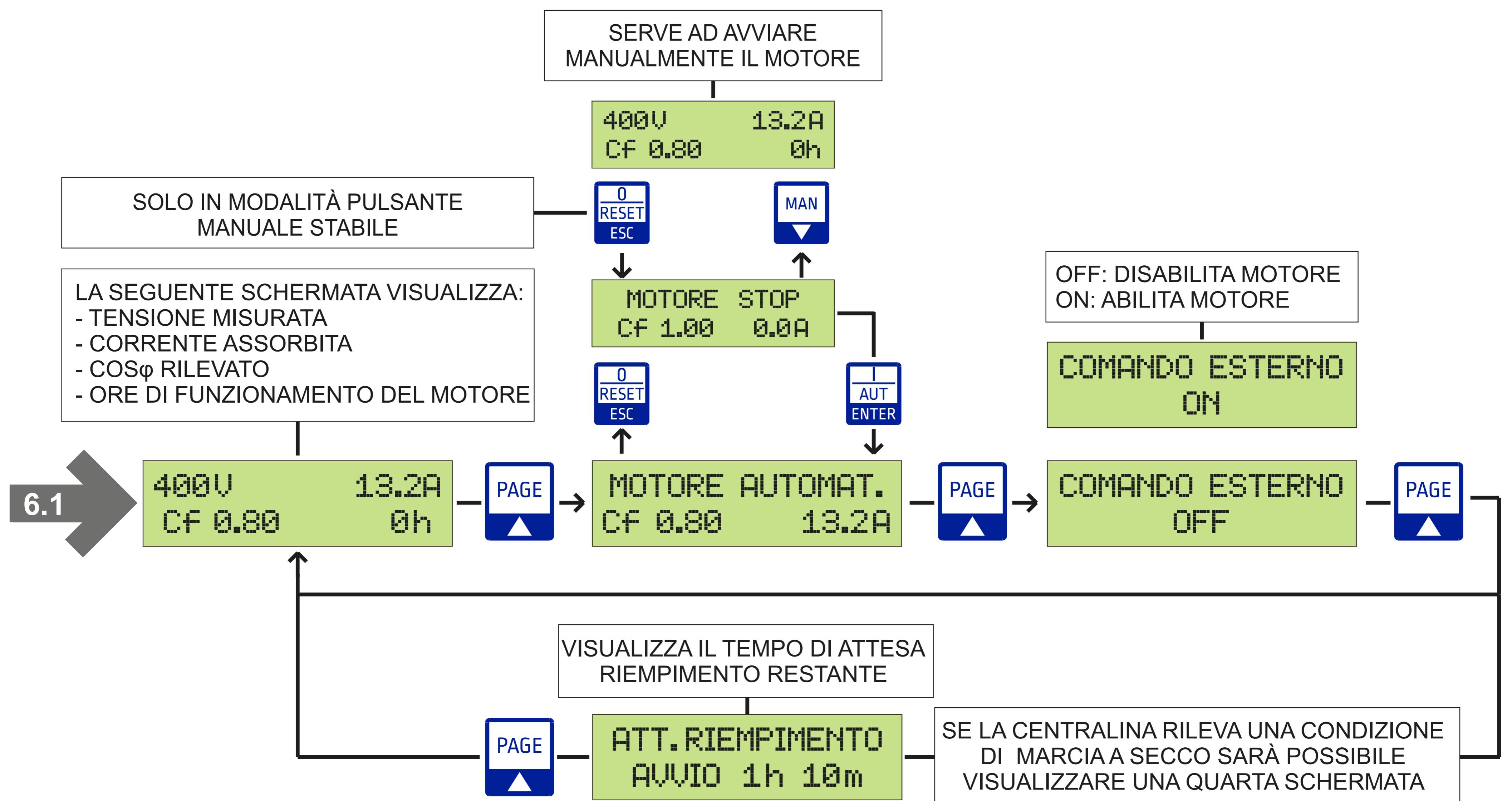

### 6.2 Applicazione cosφ



	Premuto arresta il motore in funzione STOP Premuto in presenza di un allarme lo resetta		Premuto avvia il motore in funzione automatico
	Serve a scorrere le pagine		Premuto in stato MOTORE STOP avvia il motore in funzione manuale

6.3 Applicazione acque pulite

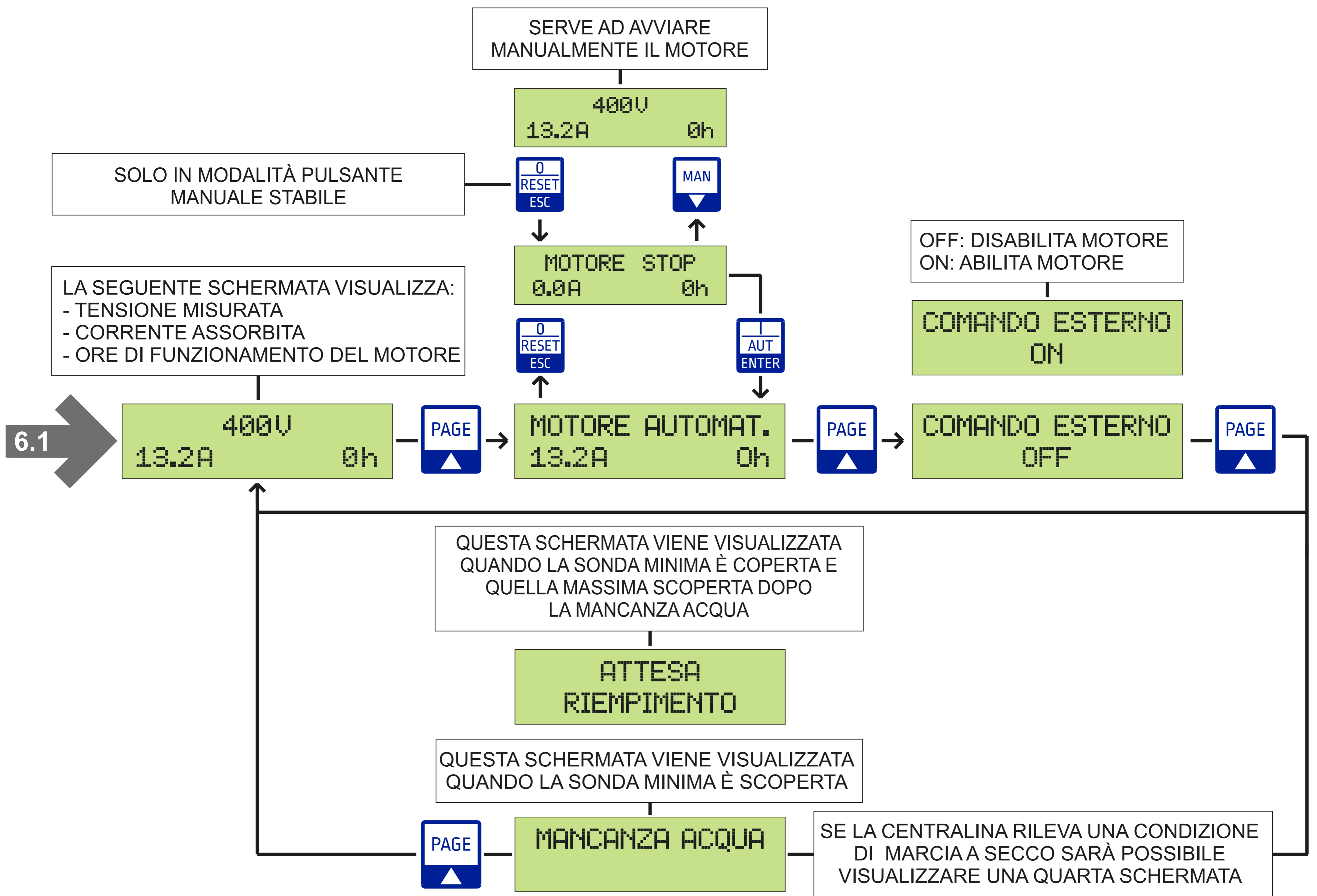

6.4 Applicazione acque reflue

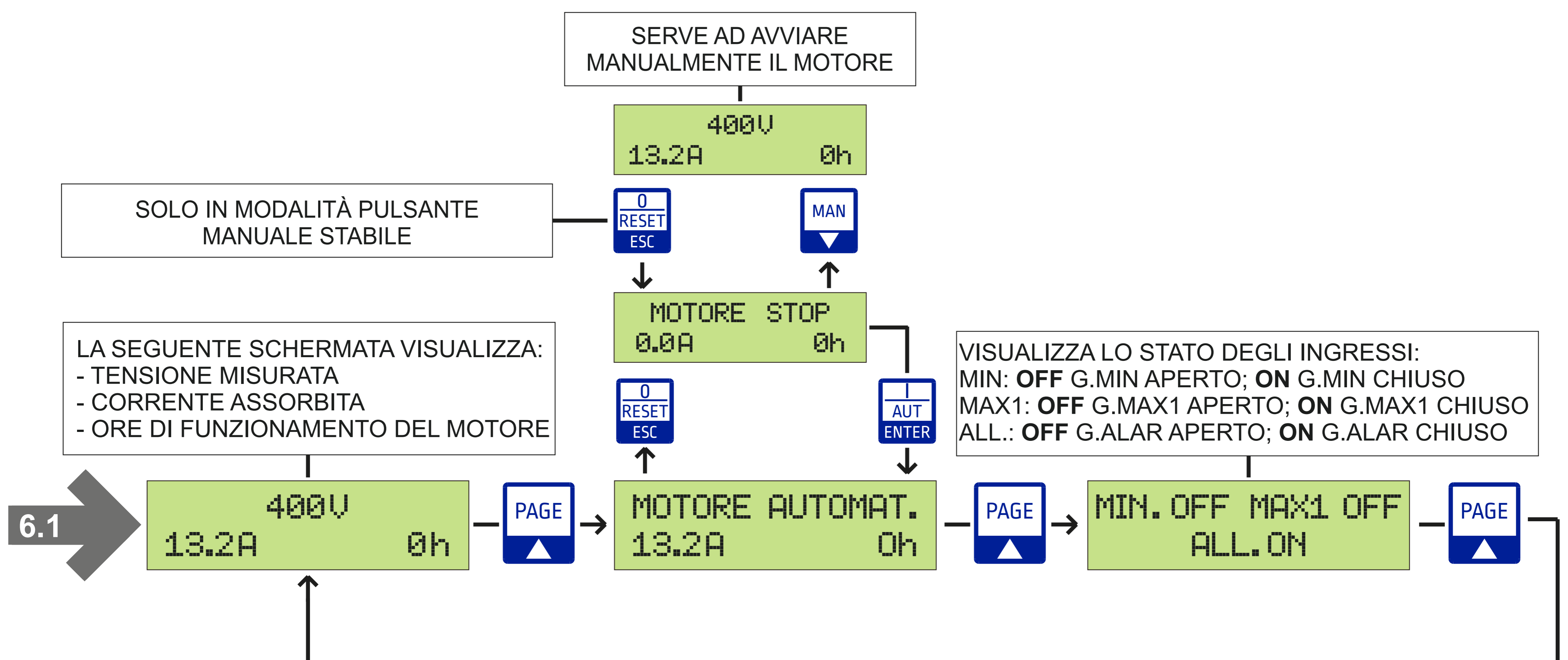





PROBLEMI COMUNI	POSSIBILI CAUSE	SOLUZIONI
Il display non si accende	Alimentazione di rete Off	Alimentare il quadro rispettando la tensione di ingresso
	Manopola del sezionatore su 0	Posizionare la manopola del sezionatore su 1
	Cavetto flat all'interno del quadro scollegato	Collegare correttamente il cavetto flat dalla scheda madre al display
Allarme CORRENTE MASSIMA	Corrente massima impostata sul setup inferiore a quella assorbita dal motore	Impostare manualmente la corrente massima il 25% in più del valore nominale
	Motore bloccato o in avaria	Scollegare il motore ed accertarsi del suo corretto funzionamento
Applicazione cosφ: COMANDO ESTERNO OFF con vasca vuota	Possibile guasto del galleggiante	Verificare la funzionalità dei galleggianti e se necessario sostituirli
Applicazione ACQUE RELFUE/PULITE: Stato GALLEGGIANTI OFF con vasca piena	Possibile guasto dei galleggianti o cavo di collegamento interrotto	Verificare la funzionalità dei galleggianti e del cavo e se necessario sostituirli
Applicazione 4-20mA bar: Valore di pressione in bar visualizzato nel display errato	Possibile otturazione o guasto del trasduttore di pressione 4-20mA	Pulire attentamente il trasduttore di pressione o se necessario sostituirlo
Applicazione 4-20mA metri: Livello in metri visualizzato nel display errato	Possibile otturazione o guasto della sonda piezoresistiva 4-20mA	Pulire attentamente la sonda piezoresistiva o se necessario sostituirla

## 8. DATA LOGGER

### 8.1 Data logger allarmi

Il data logger allarmi serve a visualizzare in ordine decrescente gli ultimi 20 allarmi salvati. La centralina insieme all'allarme registra anche le ore di funzionamento del motore in cui è stato generato.

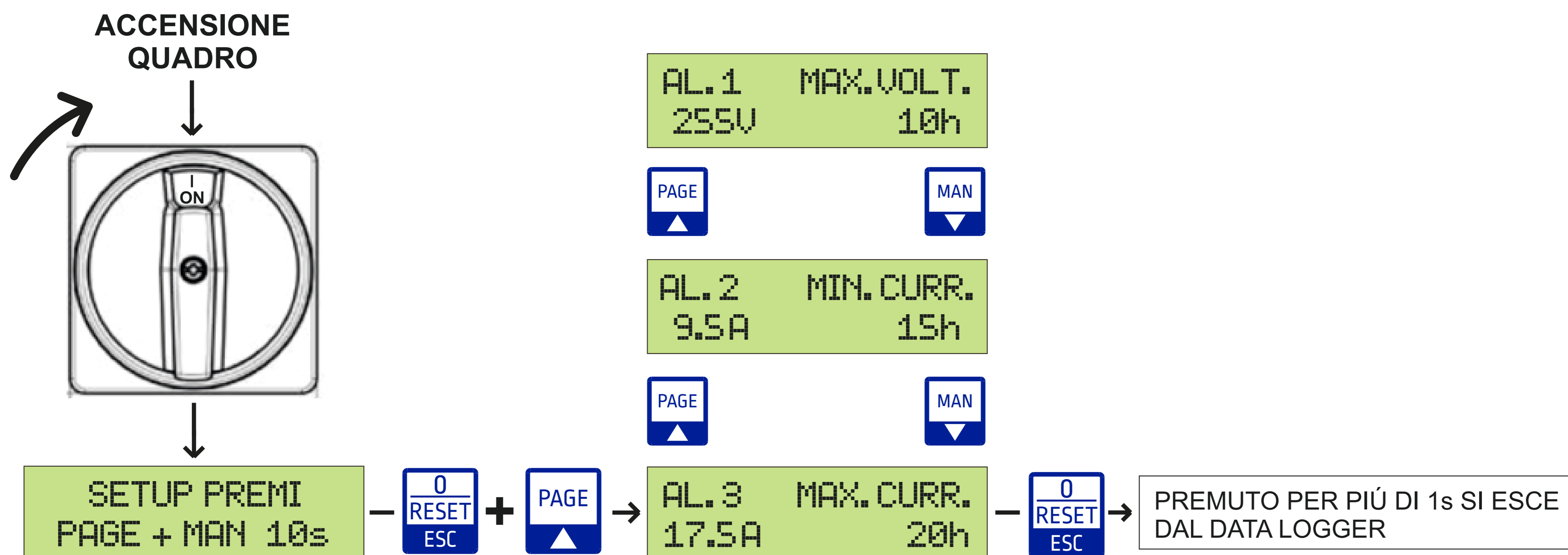

### 8.2 Data logger eventi

Il data logger eventi serve a visualizzare in ordine decrescente le ultime 20 modifiche effettuate nel setup relative alle protezioni del motore:

- Tensione minima e massima
- Corrente minima e massima
- Cosφ minimo
- Massimo numero di avviamenti ora

La centralina insieme all'evento registra anche le ore di funzionamento del motore in cui è stato generato.

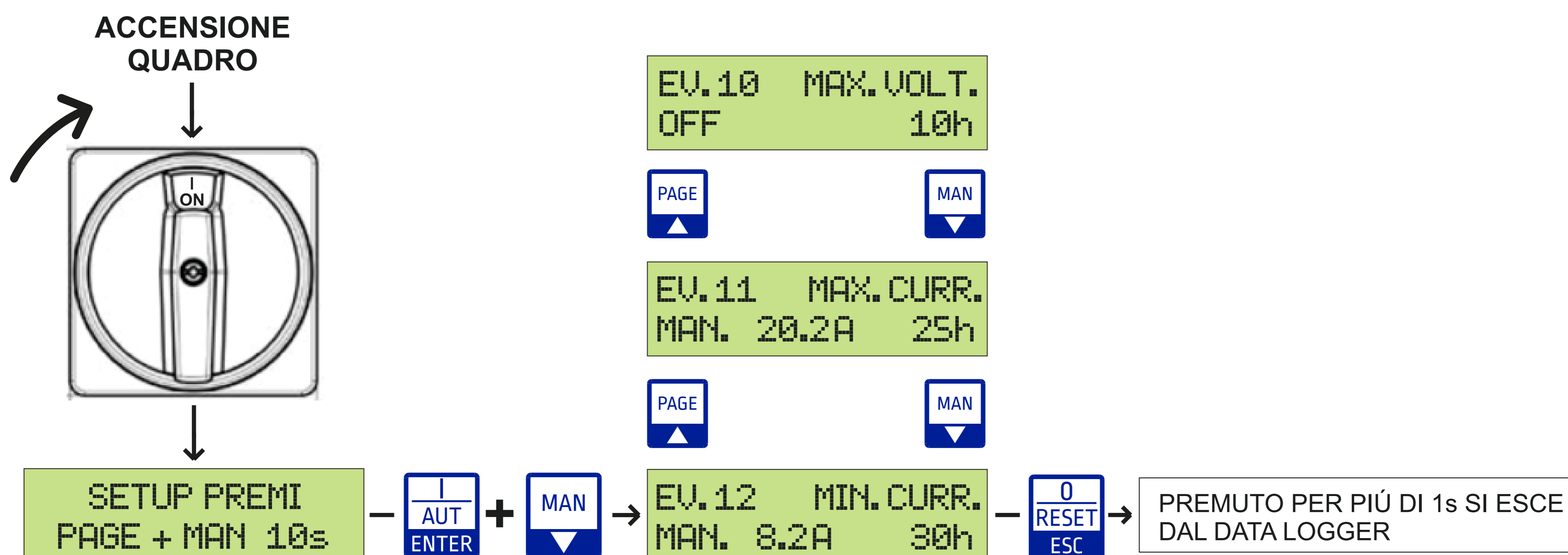

DATA LOGGER	SCHERMATA	DESCRIZIONE
✓	CORRENTE MASSIMA PREMI RESET	Se la corrente assorbita dal motore supera quella impostata nel setup, la centralina spegne il motore ed il display visualizza il seguente messaggio.
✓	CORRENTE MINIMA PREMI RESET	Se la corrente assorbita dal motore risulta inferiore a quella impostata nel setup, la centralina spegne il motore ed il display visualizza il seguente messaggio.
✓	ALLARME TENSIONE MINIMA	Se la tensione di rete scende sotto la tensione minima e tale condizione persiste per 5 secondi interviene l'allarme, il motore non viene più alimentato e sarà possibile visualizzare il seguente messaggio. Se la tensione rientra nel valore di range impostato e vi rimane per 60 secondi, la centralina ripristina automaticamente l'allarme.
✓	ALLARME TENSIONE MASSIMA	Se la tensione di rete supera la tensione massima e tale condizione persiste per 0,5 secondi interviene l'allarme, il motore non viene più alimentato e sarà possibile visualizzare il seguente messaggio. Se la tensione rientra nel valore di range impostato e vi rimane per 60 secondi, la centralina ripristina automaticamente l'allarme.
✓	ALLARME MANCANZA FASE	Se la centralina rileva la mancanza di una delle tre fasi R,S, o T, (SA687.xx) il display visualizza il seguente messaggio.
✓	ALLARME FASI RST INVERSE	Qualora il senso del ciclo delle tensioni in ingresso R,S, o ,T (SA687.xx) risulta invertito il display visualizza il seguente messaggio.
✓	MAX AVVIAM. MOT. PREMI RESET	Se il numero di avviamenti orari supera la soglia impostata, la centralina spegne il motore e il display visualizza la seguente schermata.
✓	KLIXON MOTORE	Se la temperatura interna del motore supera la soglia del termico KLIXON, la centralina spegne il motore ed il display visualizza il seguente messaggio.
	ALLARME LIVELLO MASSIMO 1.50m	Se il livello di acqua nella vasca supera il livello impostato nel parametro LIVELLO ALLARME il display visualizza la seguente schermata.
	PRESSIONE MINIMA PREMI RESET	Se la pressione nell'impianto scende al di sotto del valore impostato nel parametro PRESSIONE MINIMA del setup, la centralina spegne il motore ed il display visualizza il seguente messaggio.

Tutti gli allarmi vengono ripristinati automaticamente ad eccezione della corrente massima che si resetta premendo per 2 s il pulsante



Nella centralina quando viene generato un qualsiasi tipo di allarme si attivano tre uscite, due 12Vdc rispettivamente per sirena e lampeggiante ed una a relè contatto pulito.

Per mezzo del pulsante  è possibile tacitare l'uscita sirena che rimarrà disattivata fino a che non verrà generato un nuovo allarme.

1. General instructions for installing.....	21
2. Warnings.....	21
3. Application examples.....	22-23
4. Wiring diagrams	
4.1 Wiring diagrams SA684.xx.....	24
4.2 Wiring diagrams SA687.xx.....	25
5. Programming	
5.1 Fast programming.....	26
5.2 Application $\cos\phi$ .....	27
5.3 Application 4-20mAbar.....	28
5.4 Application 4-20mA meters.....	29
5.5 Advanced programming.....	30-31
6. General functioning of the control panel	
6.1 General functioning.....	32
6.2 Application $\cos\phi$ .....	32
6.3 Application clean water.....	33
6.4 Application sewage.....	33
6.5 Application 4-20mA bar.....	34
6.6 Application 4-20mA meters.....	34
7. Troubleshooting and proposed solutions.....	35
8. Data logger	
8.1 Alarm data logger.....	36
8.2 Event data logger.....	36
9. Alarm messages.....	37
10. Disposal of electrical & electronic equipment.....	38
11. Declaration of conformity.....	38

Make sure power supply is protected up to standard depending on application. The power of the motor has to be within the control panel's limits of use.

Install the control panel in an environment appropriate to its IP65 degree of protection. To fix the enclosure, use the brackets for the boxes 03-04 and the special predispositions for the remaining boxes. In order to fix the box, use the appropriate holes which are present or suggested on the bottom. Pay particular attention to not touching or damaging any components while fixing the box.

Eliminate whatever metal and/or plastic impurity which could happen to fall inside the box (screws, washers, dust...).

When connecting electric cables, follow the wiring diagrams.

When fixing the cables in the terminal board use tools of correct size to avoid damaging the metal feed clamps and their sockets.





Before acting upon anything inside, disconnect power supply. Regulation procedures must be carried out by qualified personnel. In case protections intervene verify the cause of the problem before resetting.

If necessary substitute the various components only with those having the same characteristics and components as the originals.

**It is the installer's duty to verify the device after the installation although it has already undergone regular testing by the manufacturer.**

**The manufacturer is released from all responsibilities for accidents to things or people, which derive from misuse of the devices by unauthorized personnel or from lack of maintenance and repair.**

2. WARNINGS

	<p><b>ELECTRIC SHOCKS</b></p> <p>Risk of electric shocks if not complied with the requirements.</p>
	<p><b>DANGER</b></p> <p>Risk of personal injury and property if not complied with the requirements.</p>
	<p><b>WARNING</b></p> <p>Before installing and using the product read this book in all its parts. Installation and maintenance must be performed by qualified personnel in accordance with current regulations. The manufacturer will not be held responsible for any damage caused by improper or prohibited use of this control panel and is not responsible for any damages caused by an incorrect installation or maintenance of the plant. The use of non-original spare parts, tempering or improper use, make the product warranty null.</p>
	<p><b>WARNING</b></p> <p>Be sure that the power of the motor is within the control panel range. Install the control panel in an environment appropriate to its IP 65 degree of protection. To operate inside the control panel use tools of correct size to avoid damaging the sockets.</p>
	<p><b>DANGER</b></p> <p>Before any intervention ensure that the control panel is disconnected from the electricity supply. Do not attempt operations when the control panel is open. The control panel must be connected to an efficient earthing system. In order to fix the box use the appropriate holes present on the bottom, don't damage internal components and eliminate any working debris inside the box. In the case of protections eliminate the cause of the malfunction before the restoration.</p>

### 3. APPLICATION EXAMPLES

Below are some practical examples of applications that can be implemented with the **MULTIPLUS 1** control panel.

**DRY RUNNING COS $\phi$  (1 INPUT)**

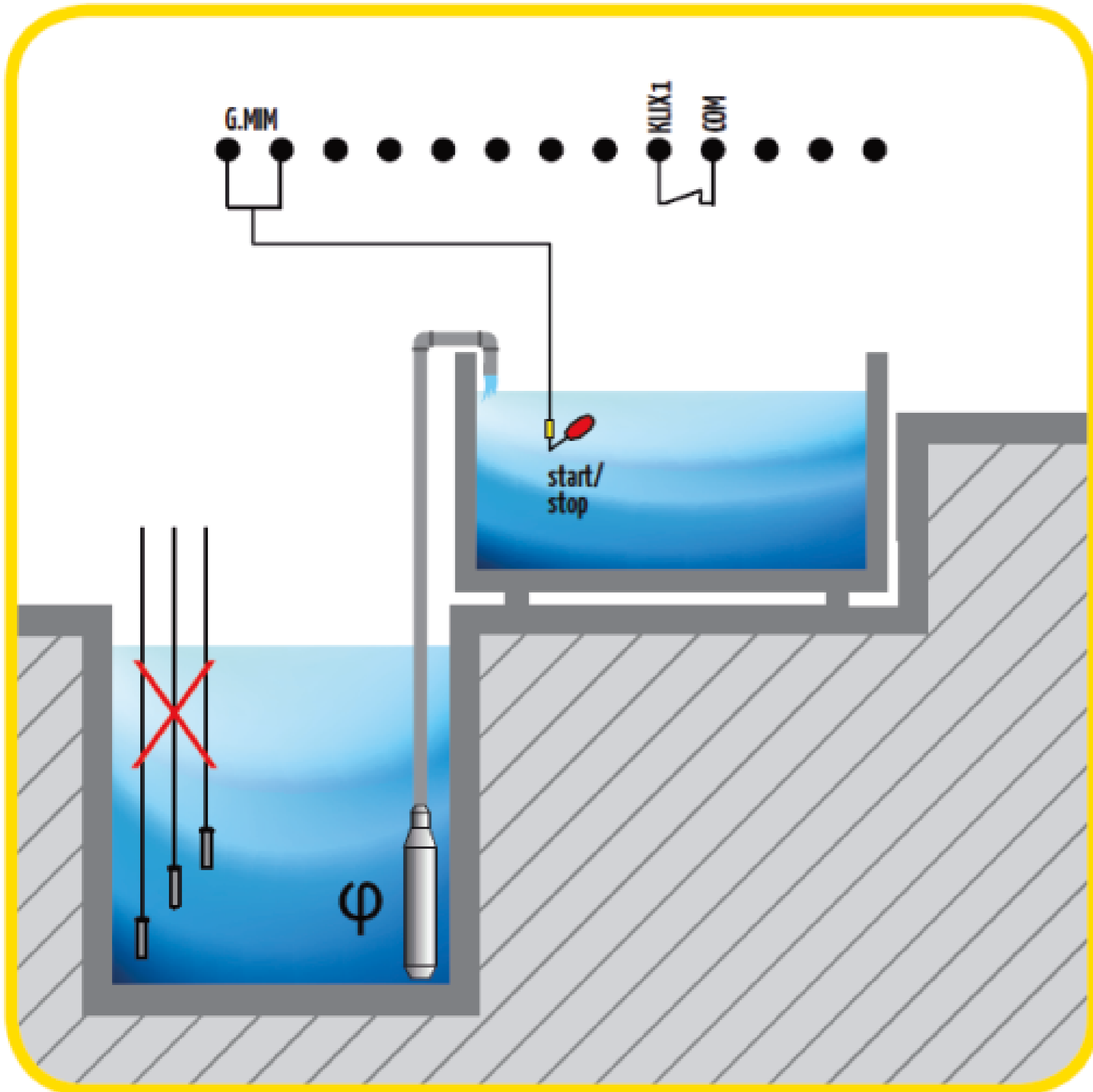

**DRY RUNNING COS $\phi$  (2 INPUTS)**

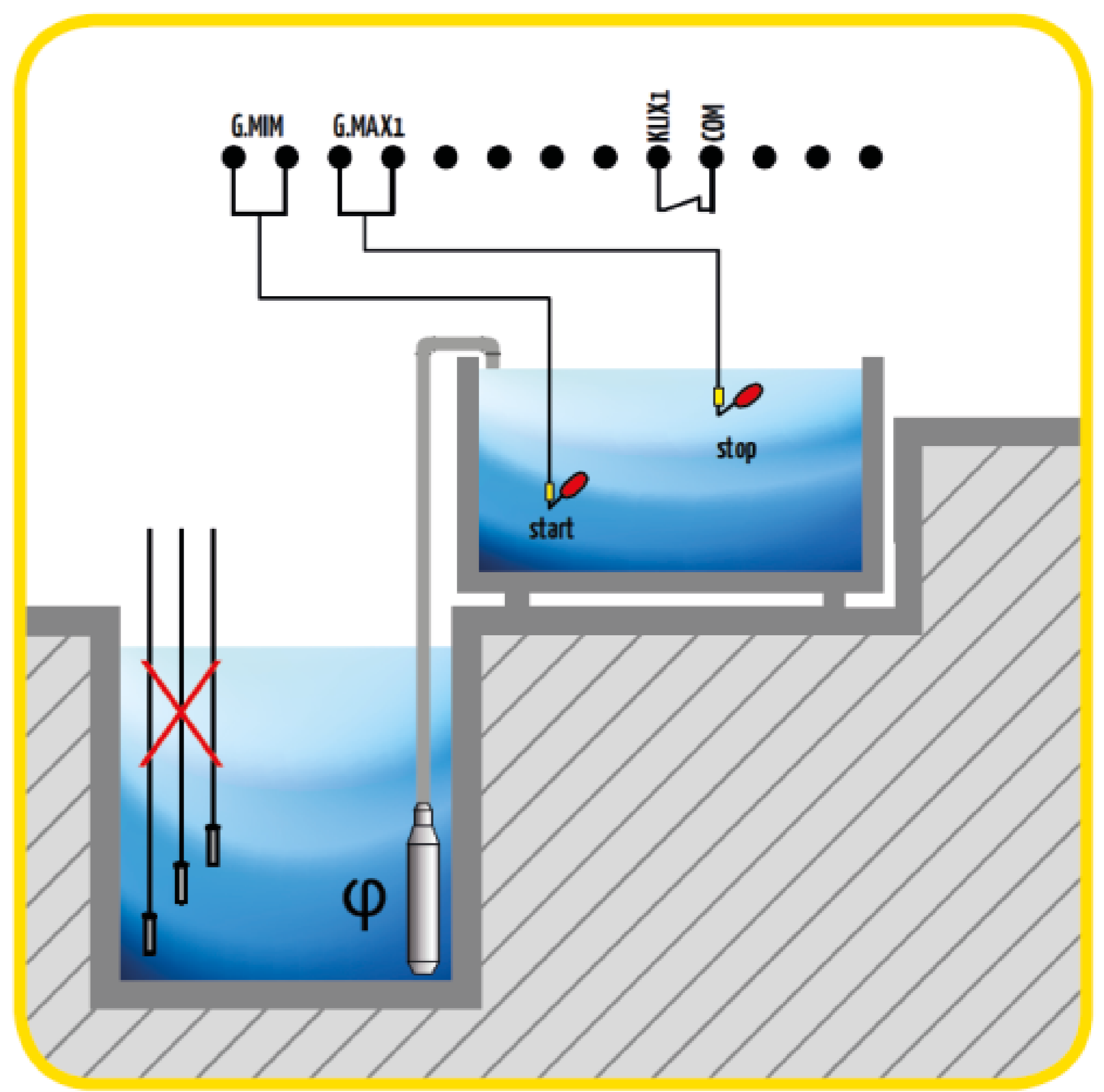

**CLEAN WATER (LIFTING)**

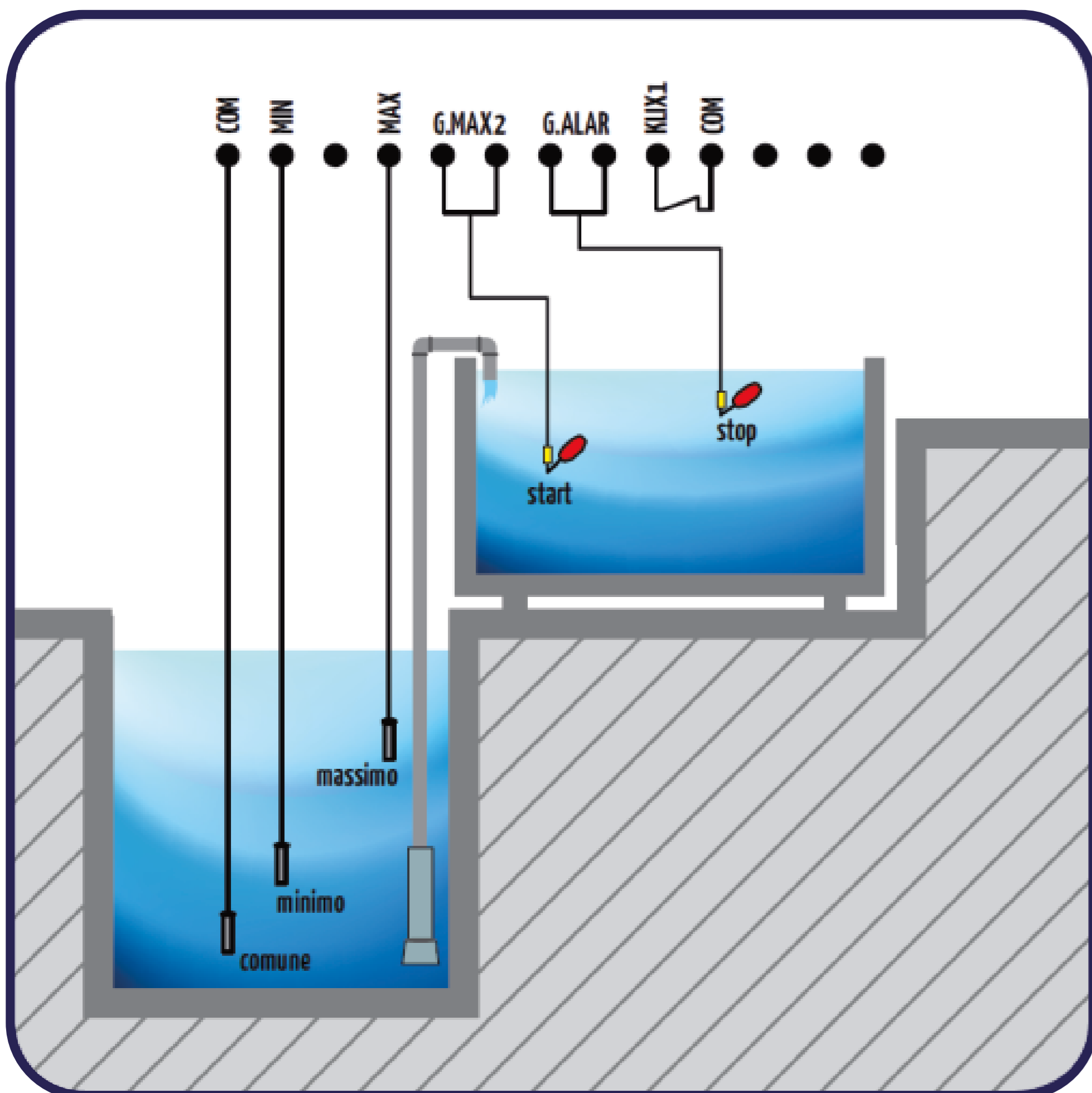

**CLEAN WATER (EMPTYING)**

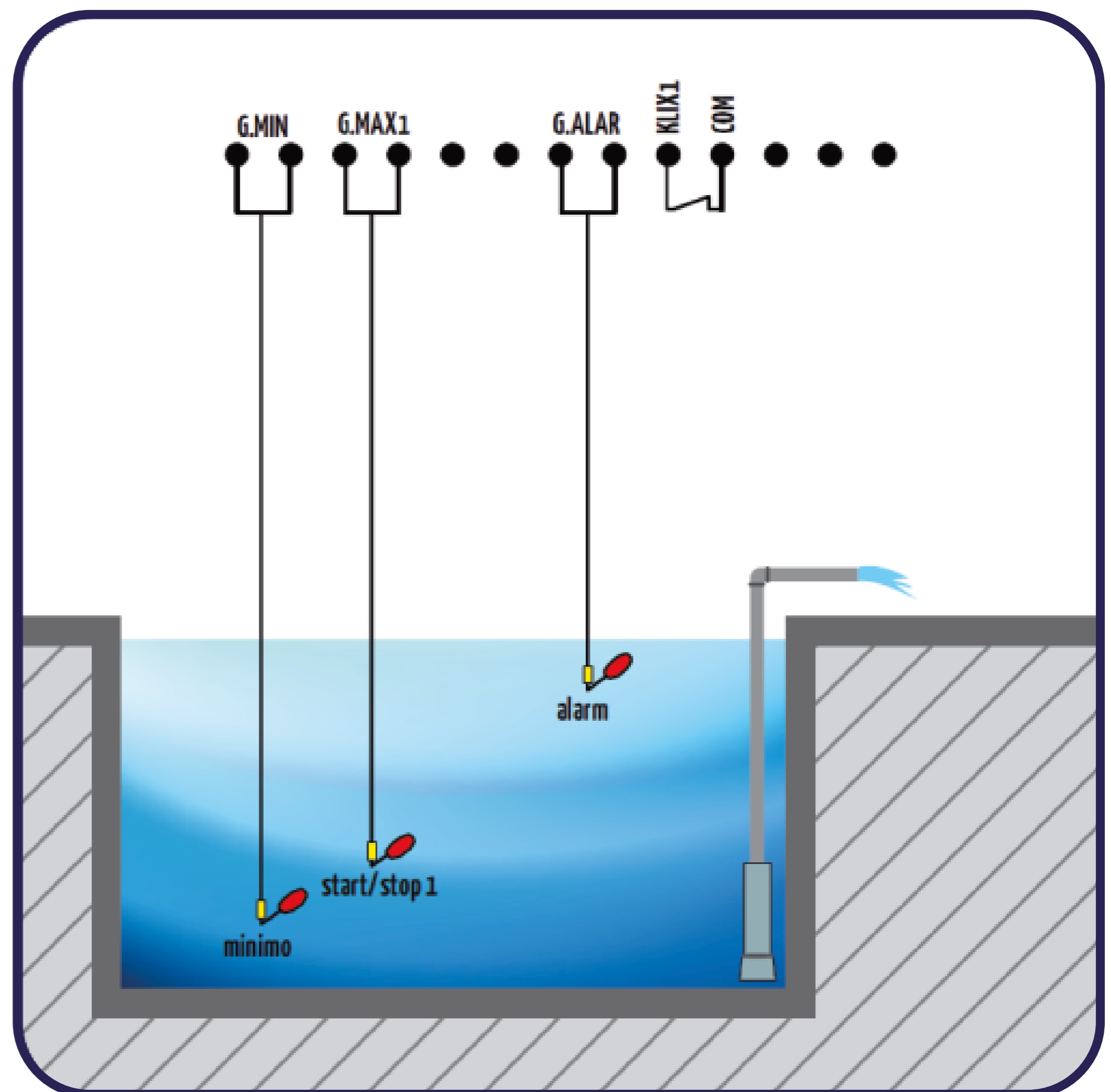

**COMPONENTS KEY**

 Float switch for clean water

 Level probe

Below are some practical examples of applications that can be implemented with the **MULTIPLUS 1** control panel.

SEWAGE

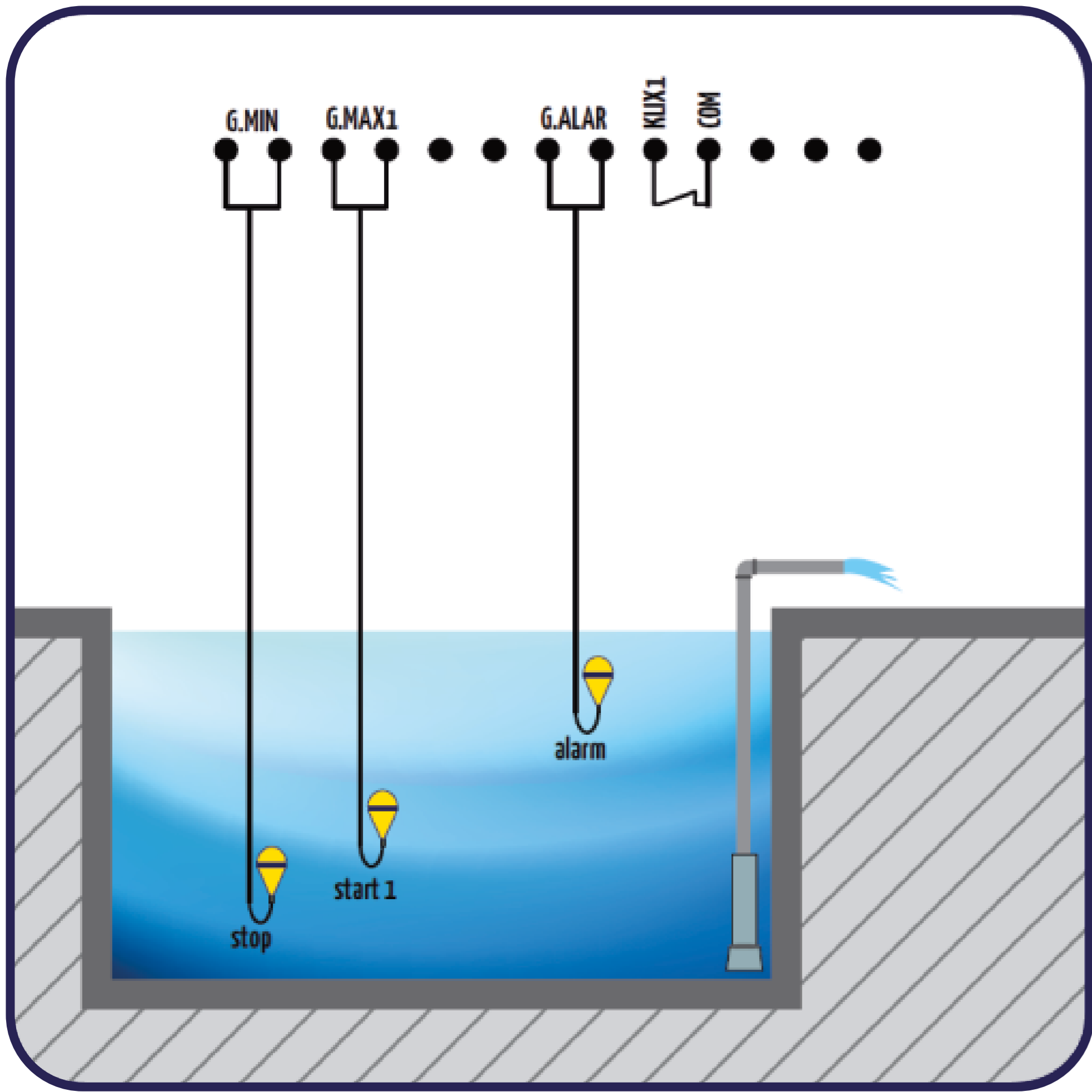

4-20mA meters

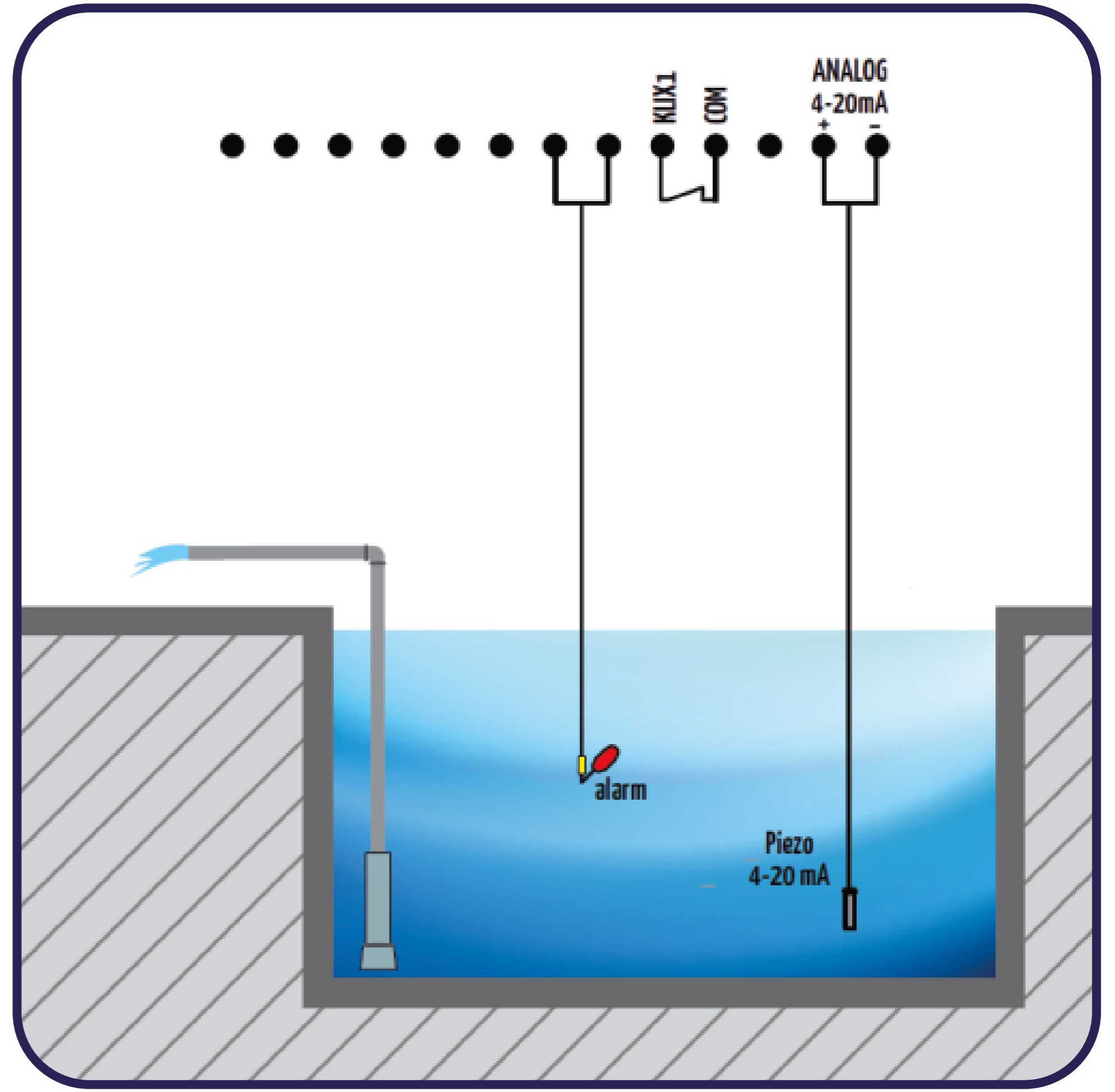

4-20mA bar

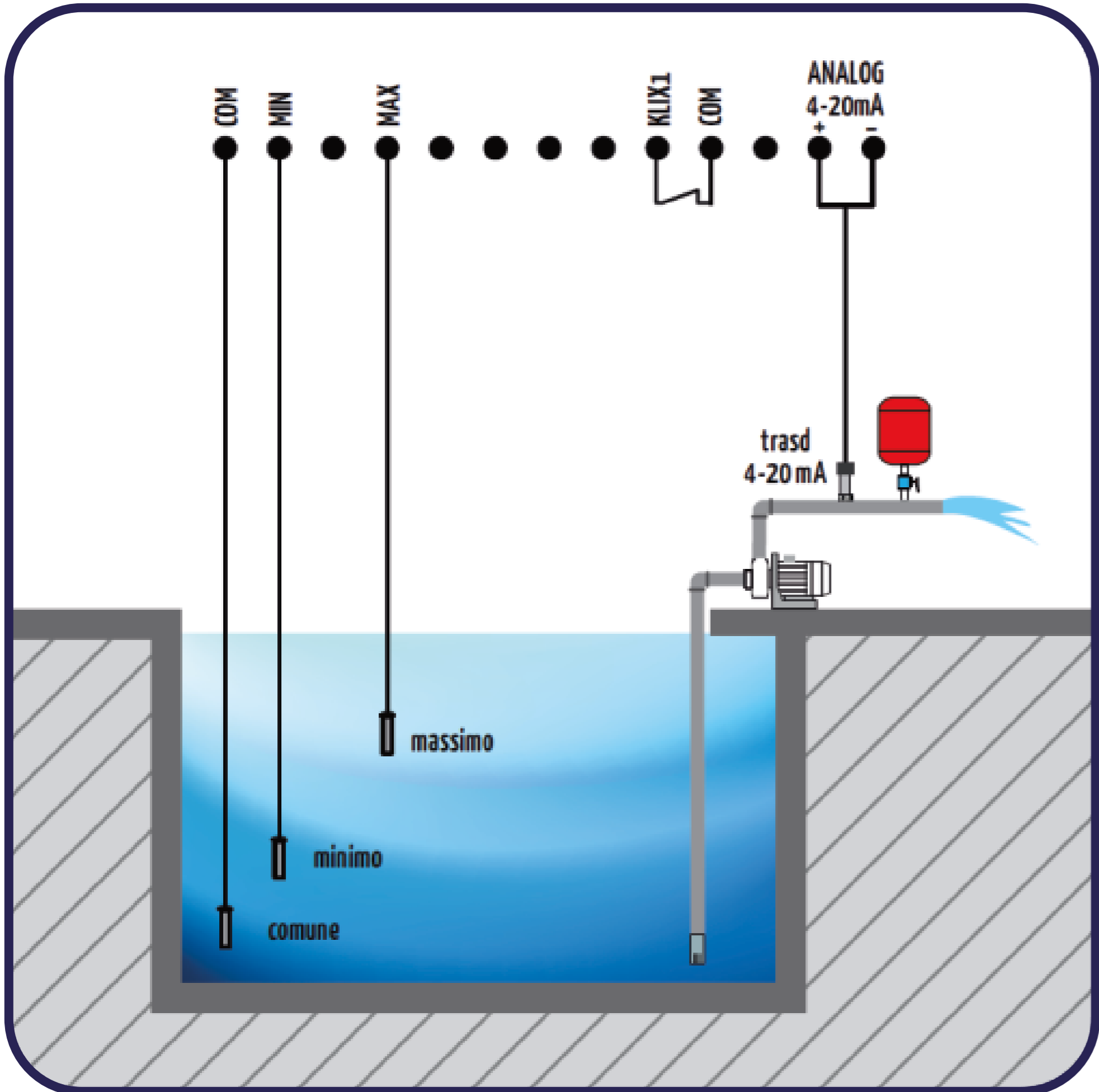

COMPONENTS KEY

 Float switch for clean water

 Float switch for sewage

 Level probe

 Pressure transducer 4-20mA

 Piezoresistive probe 4-20mA

# 4. WIRING DIAGRAMS

## 4.1 Wiring diagram SA684.xx

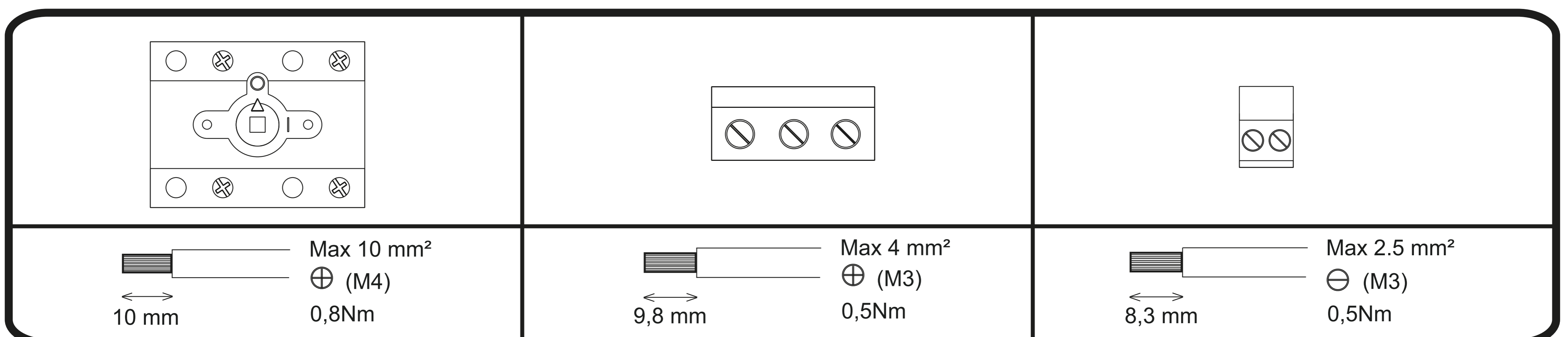
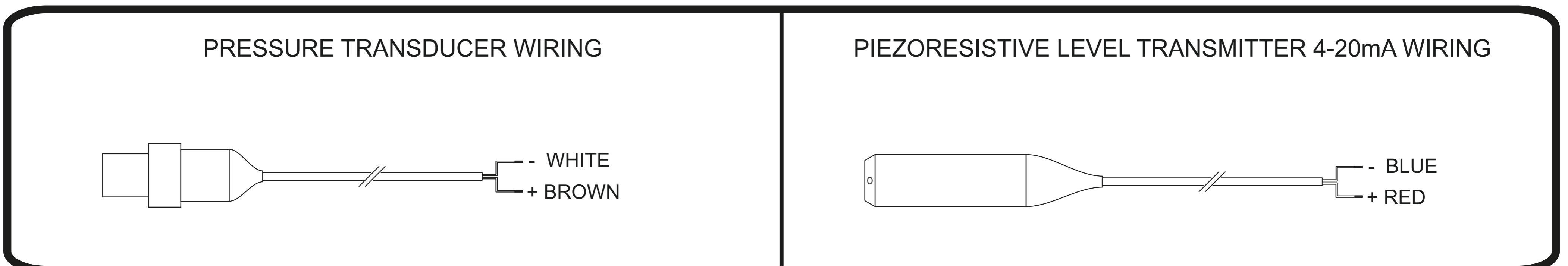
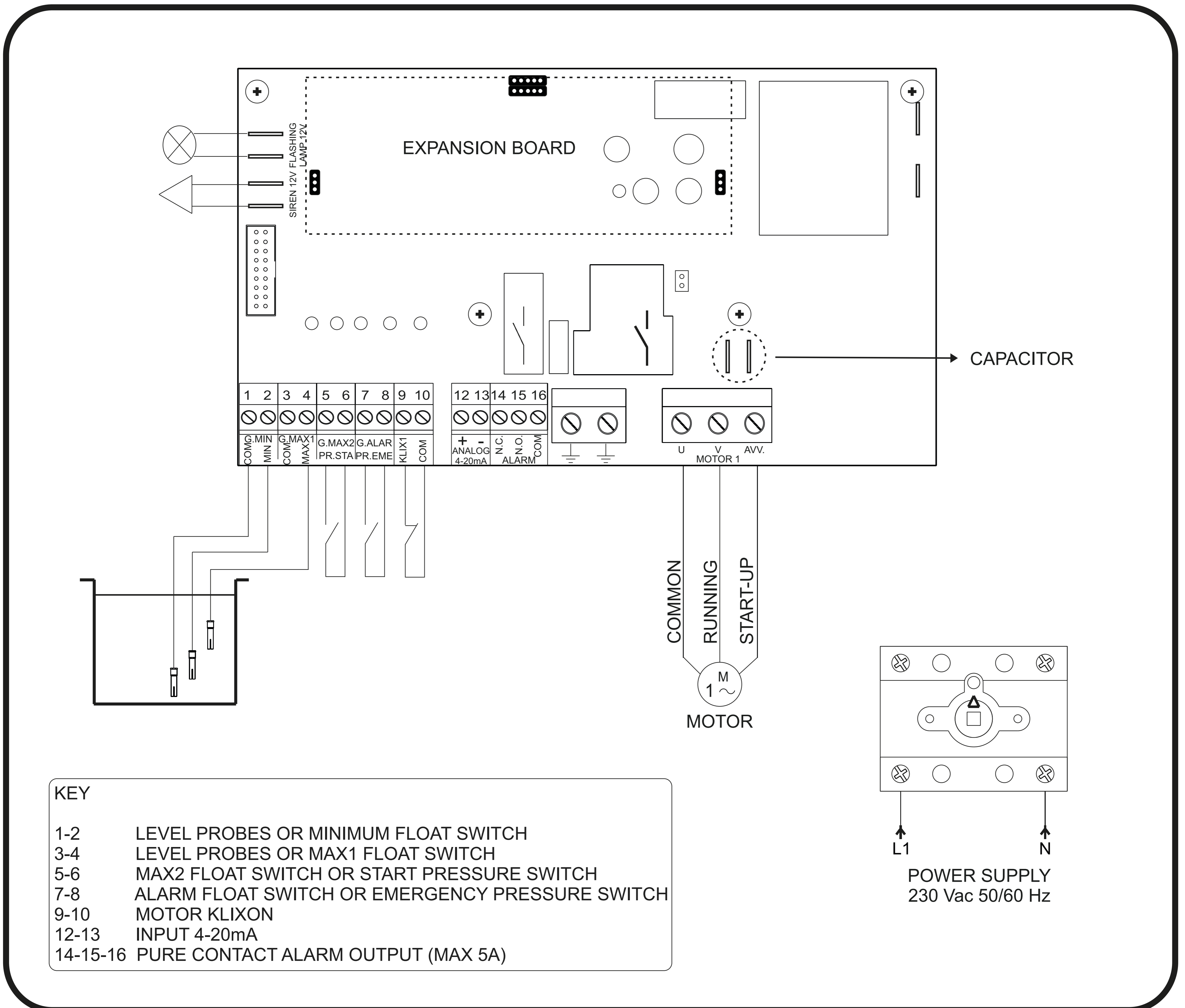



4.2 Wiring diagram SA687.xx

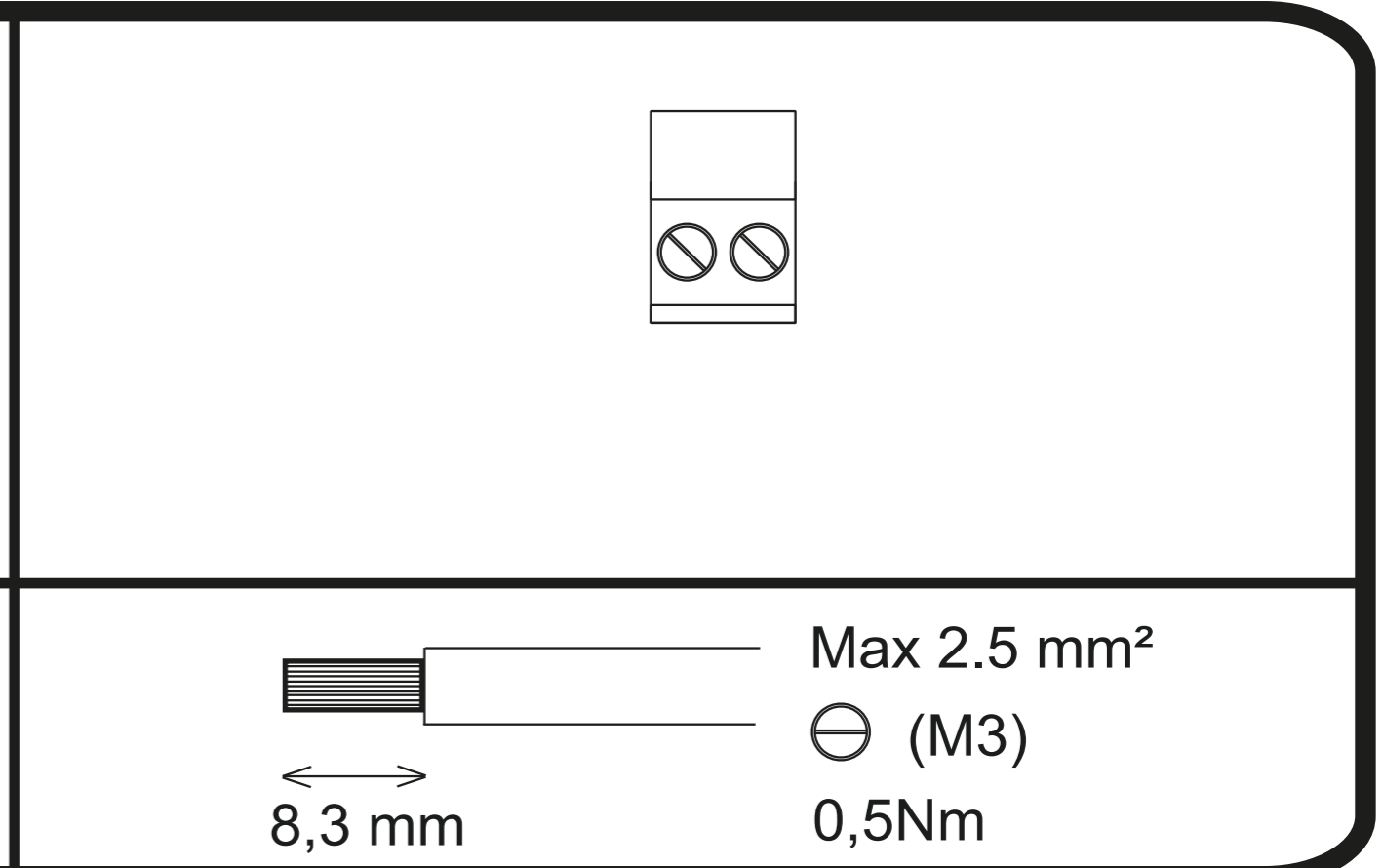
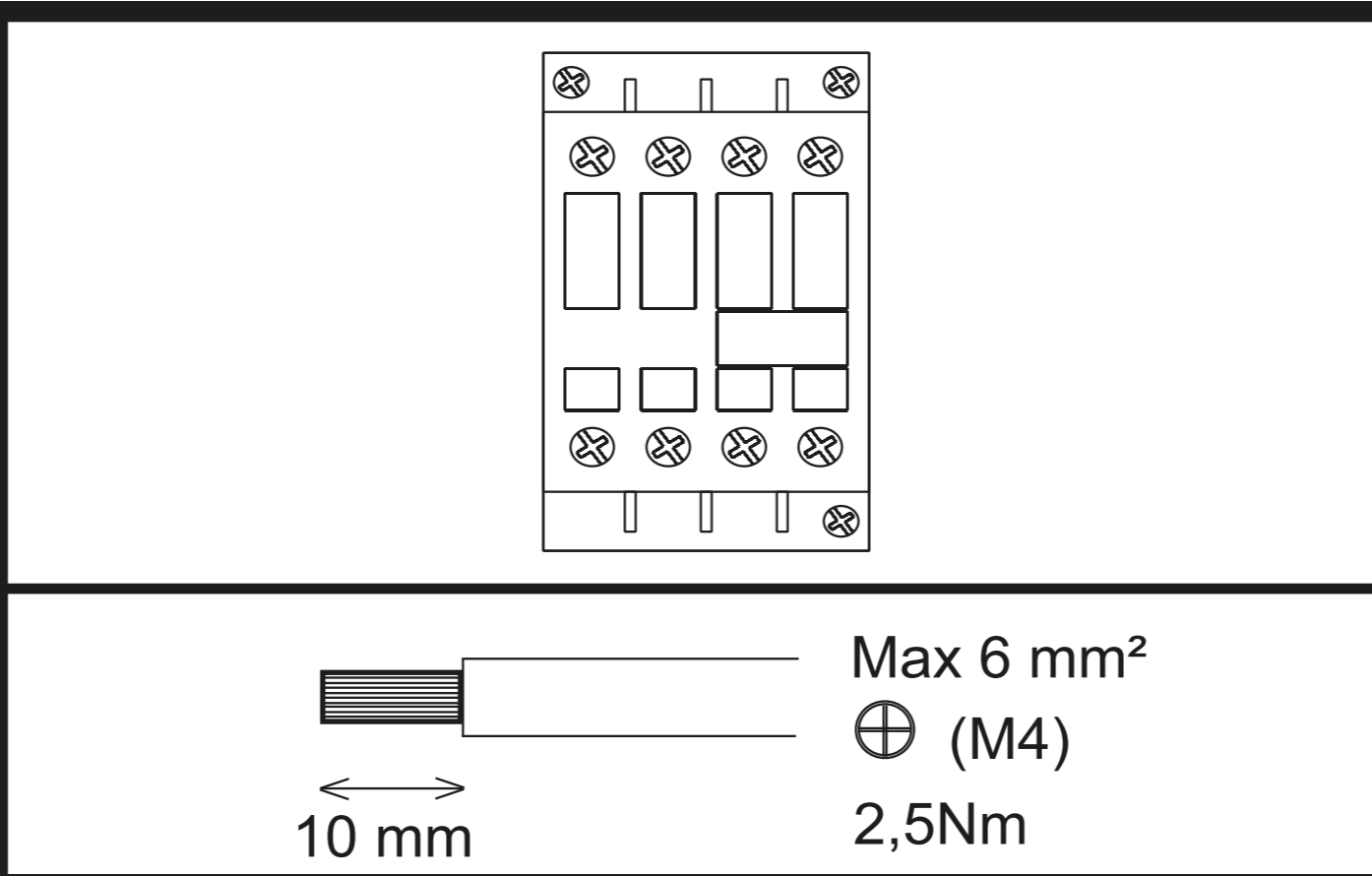
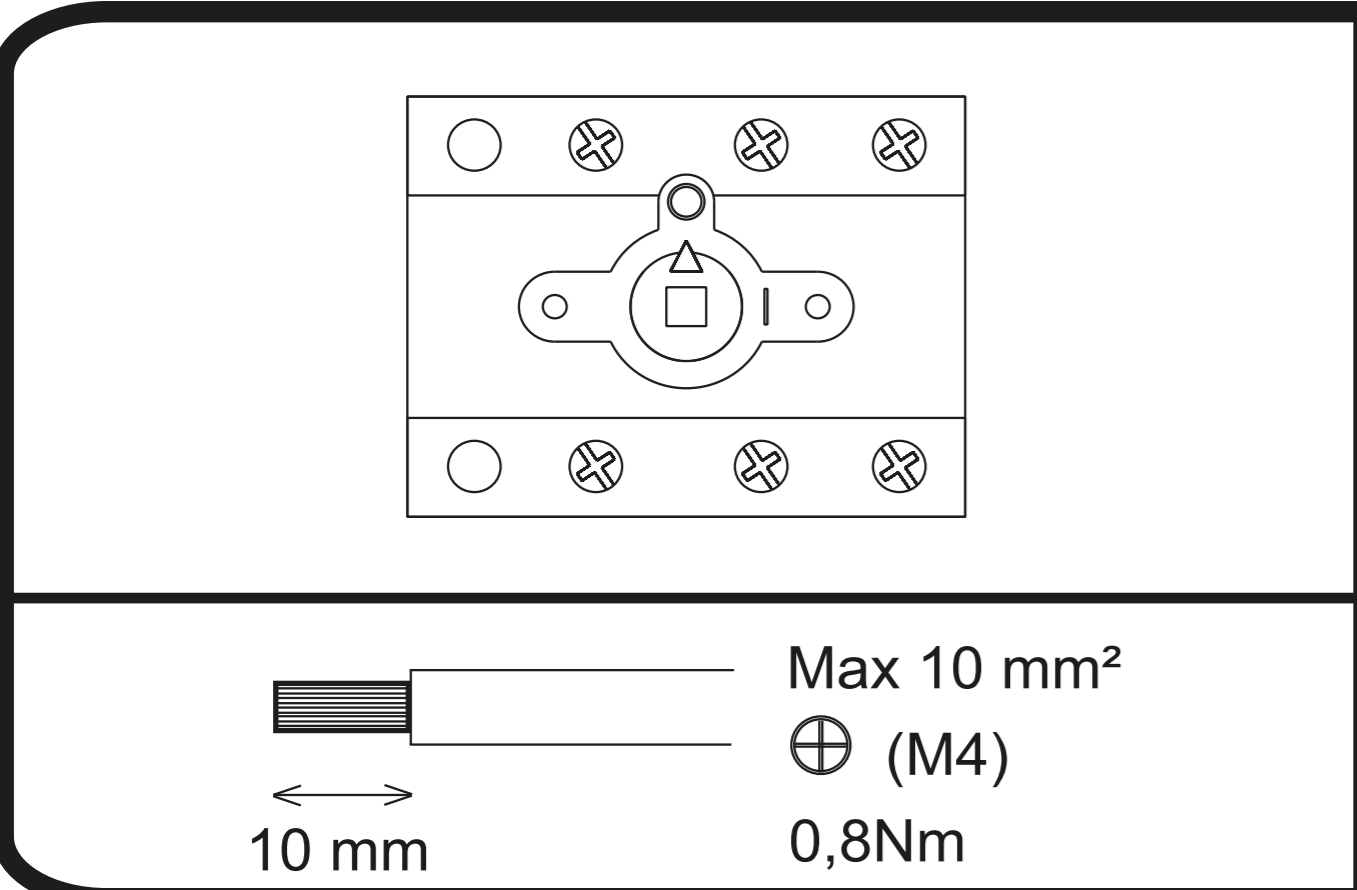
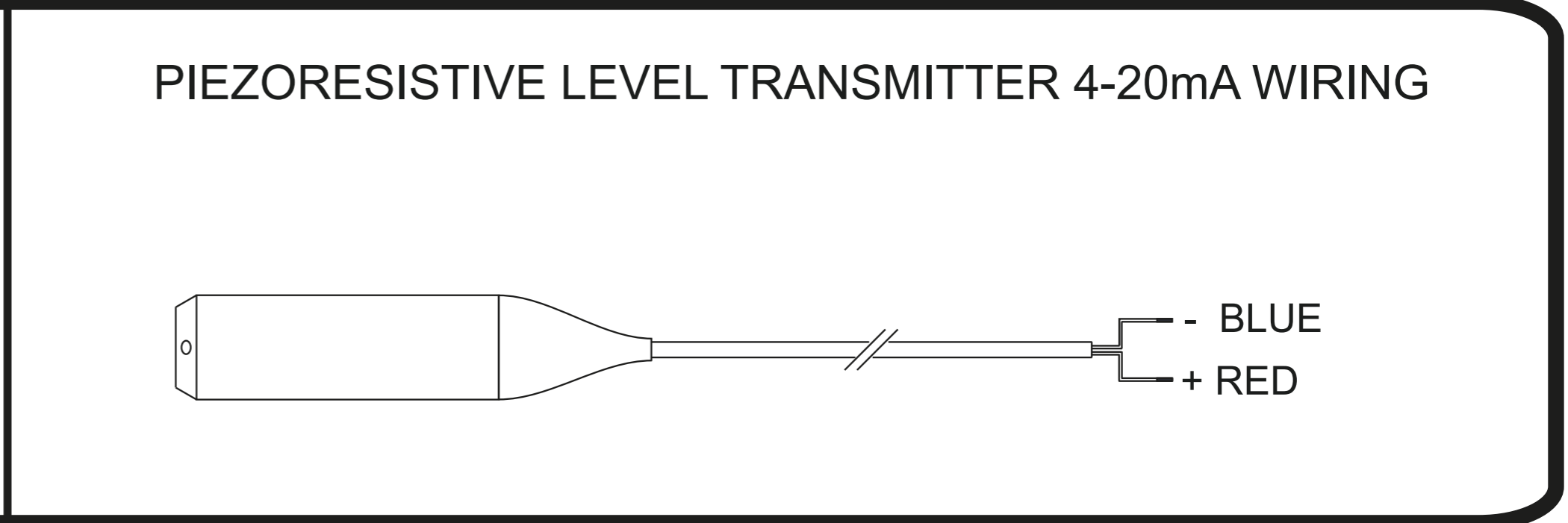
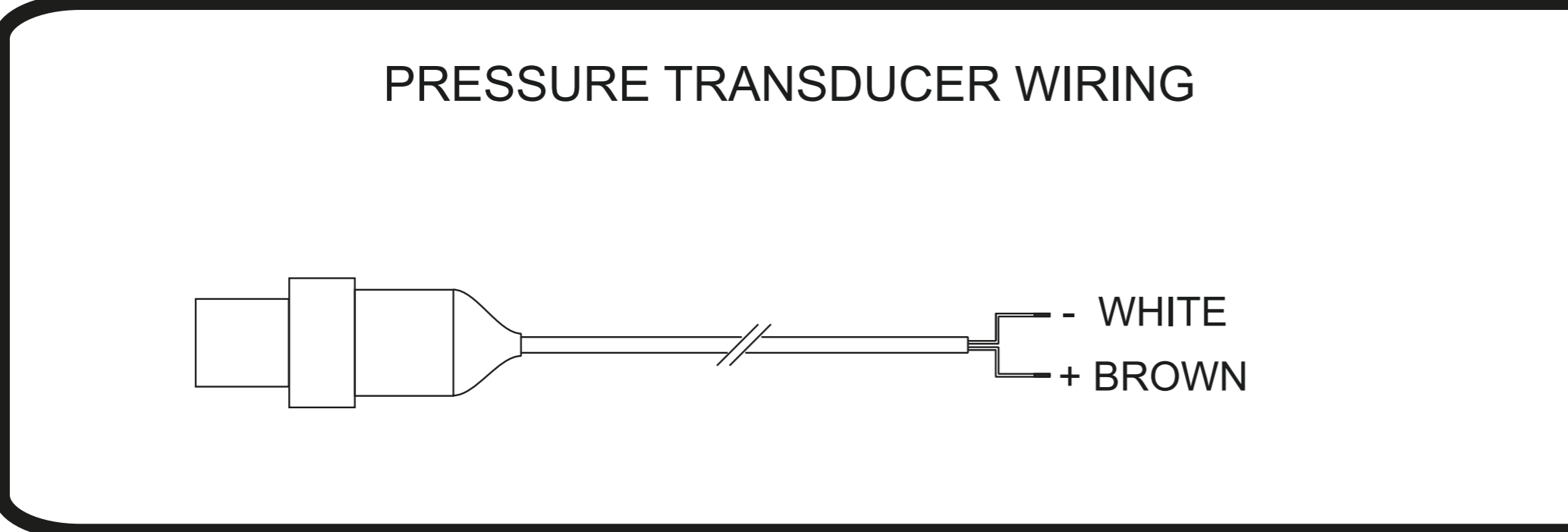
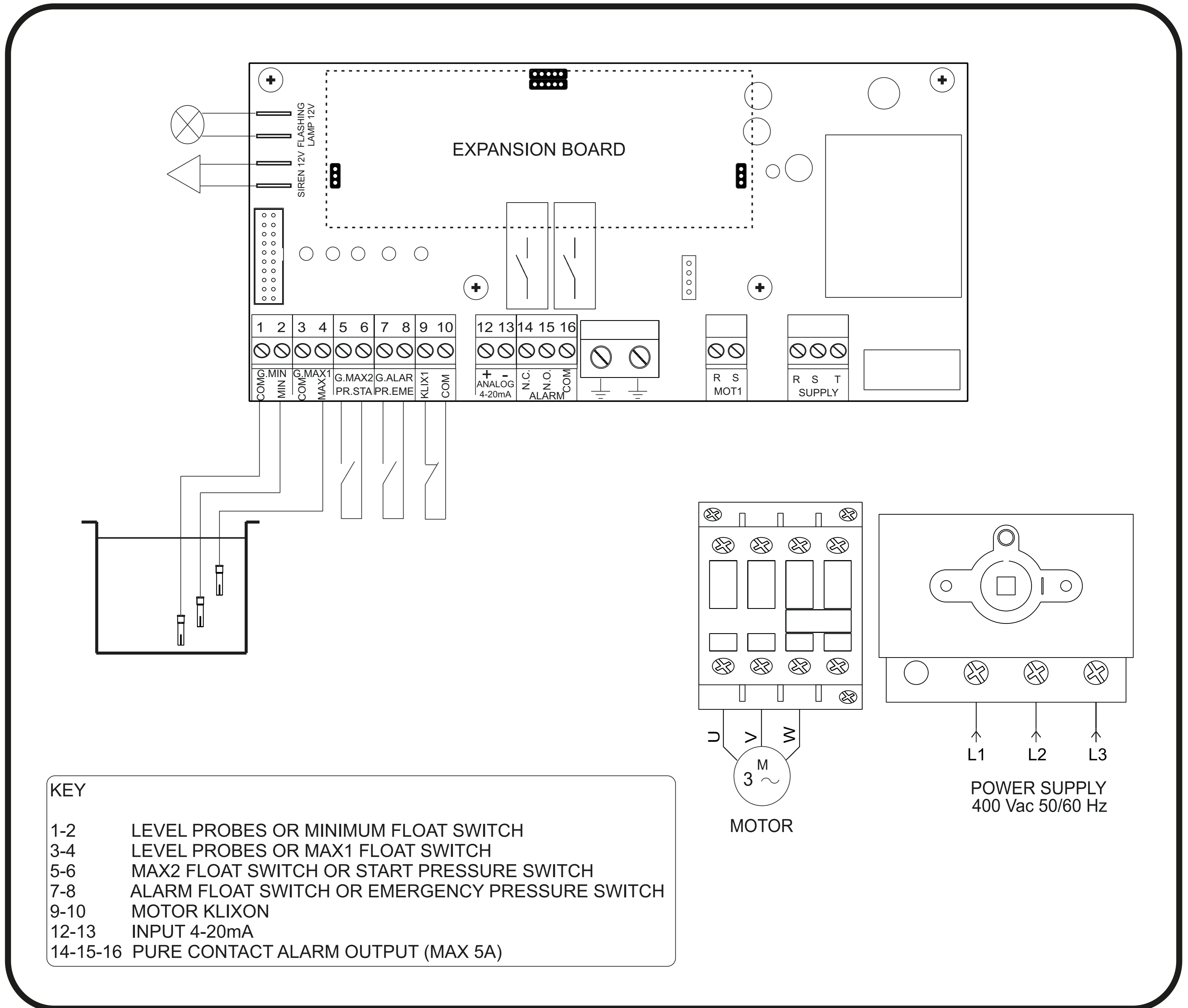

# 5. PROGRAMMING

## 5.1 Fast programming ☆

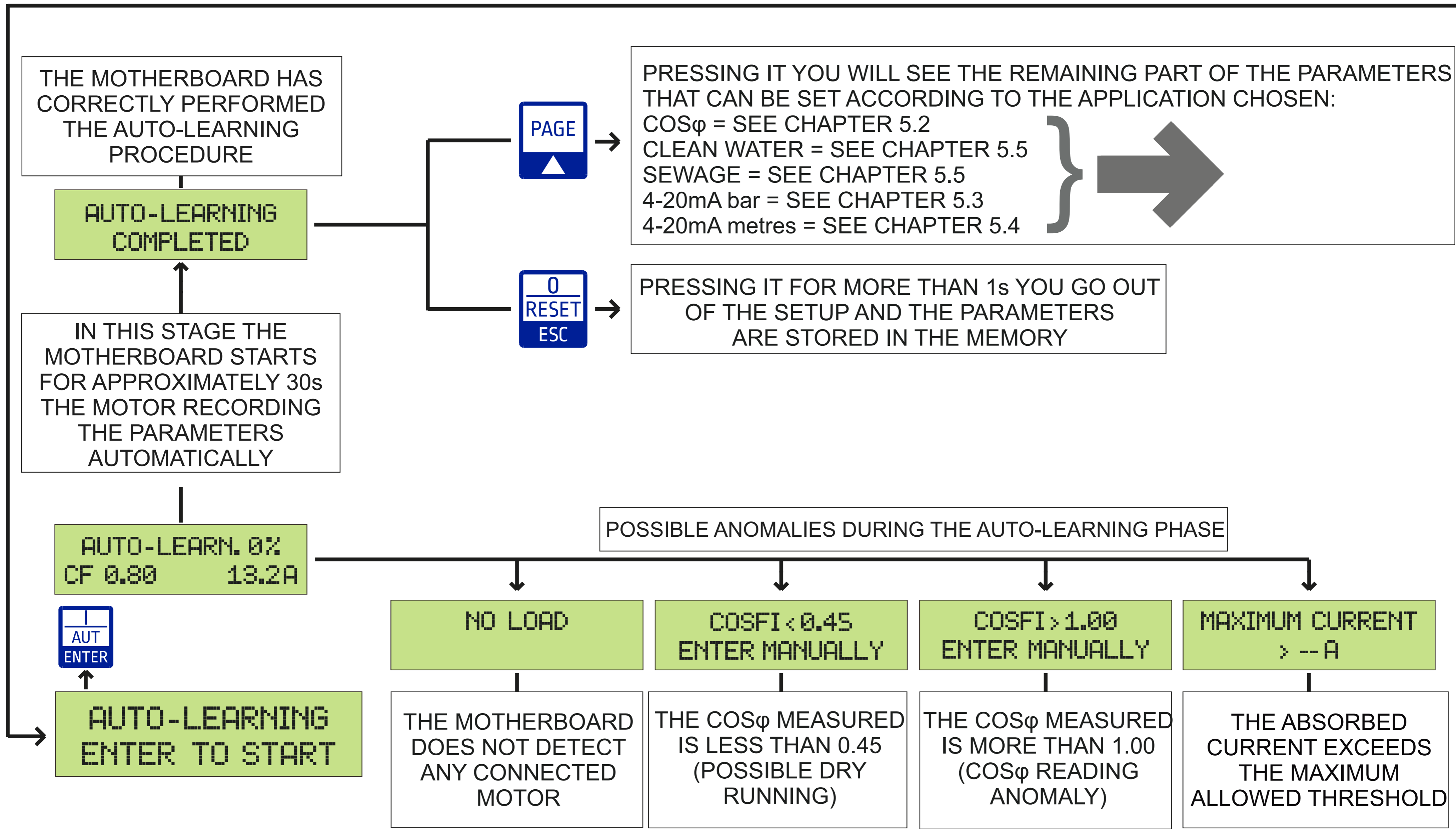
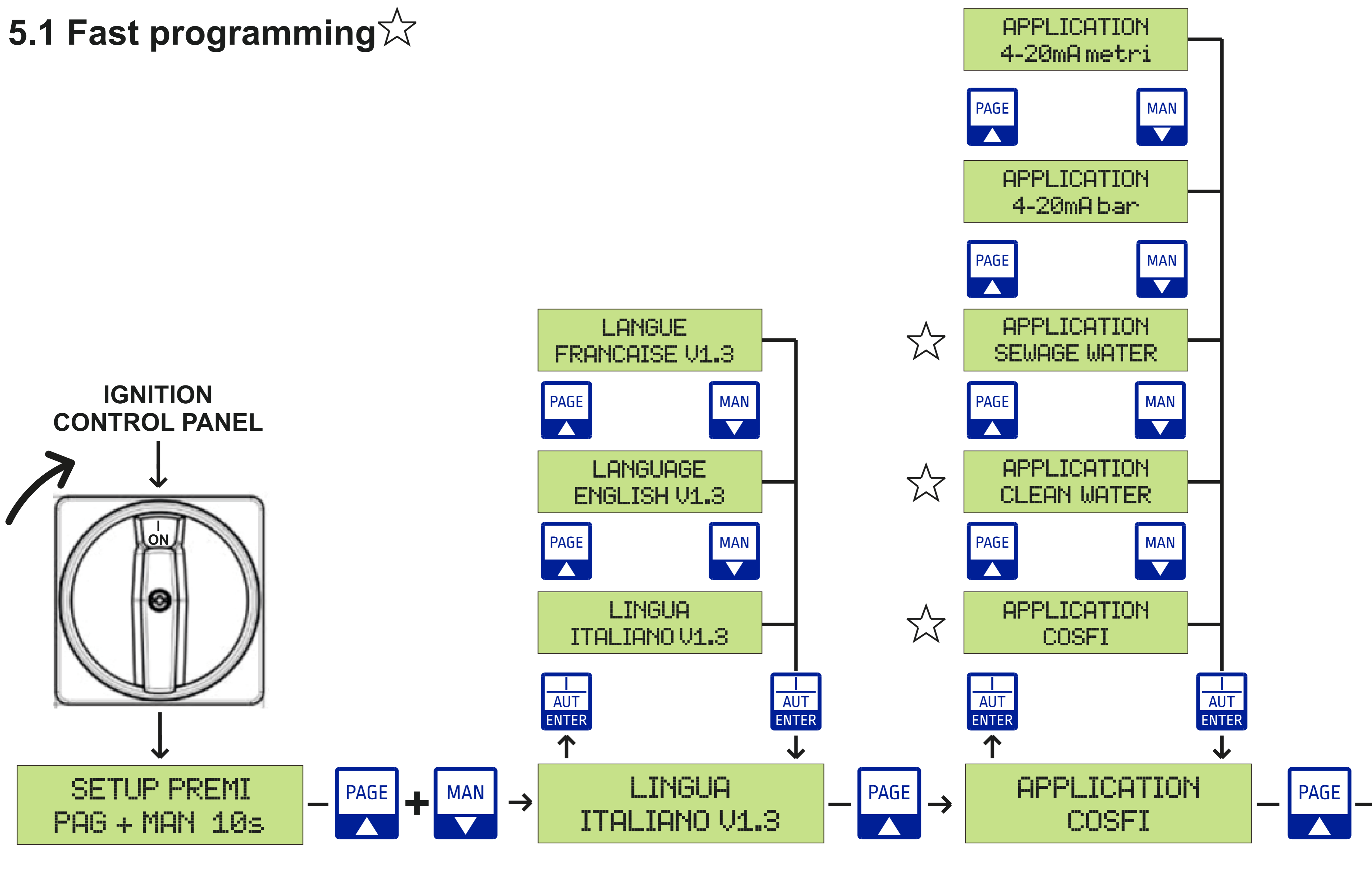

	Pressed it exits the parameter		Pressed it allows to enter the selected parameter Pressed confirms the set value
	It is used to scroll forward through the setup pages It is used to increase the value of a parameter		It is used to scroll back through the setup pages It is used to reduce the value of a parameter

5.2 Application  $\cos\phi$

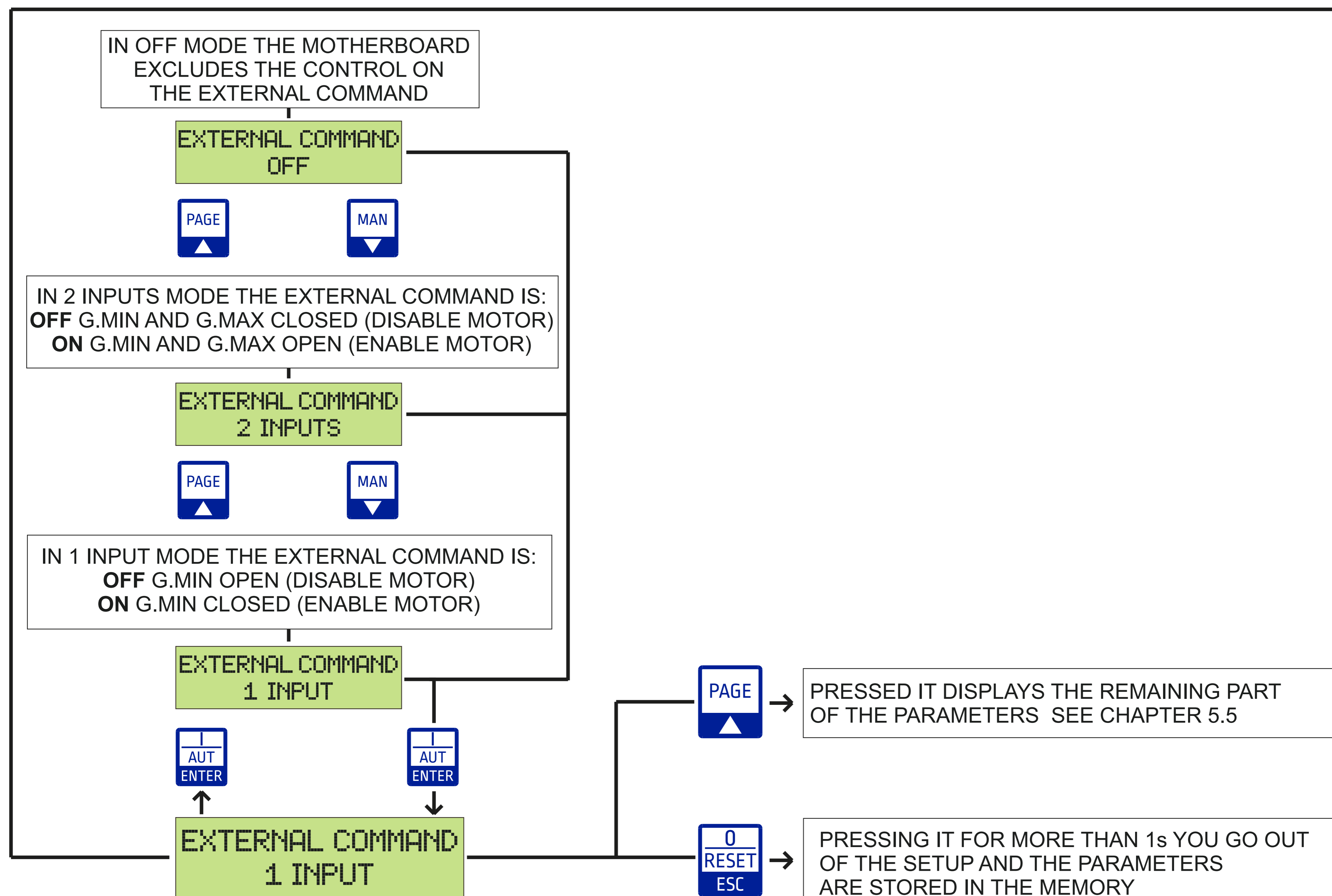
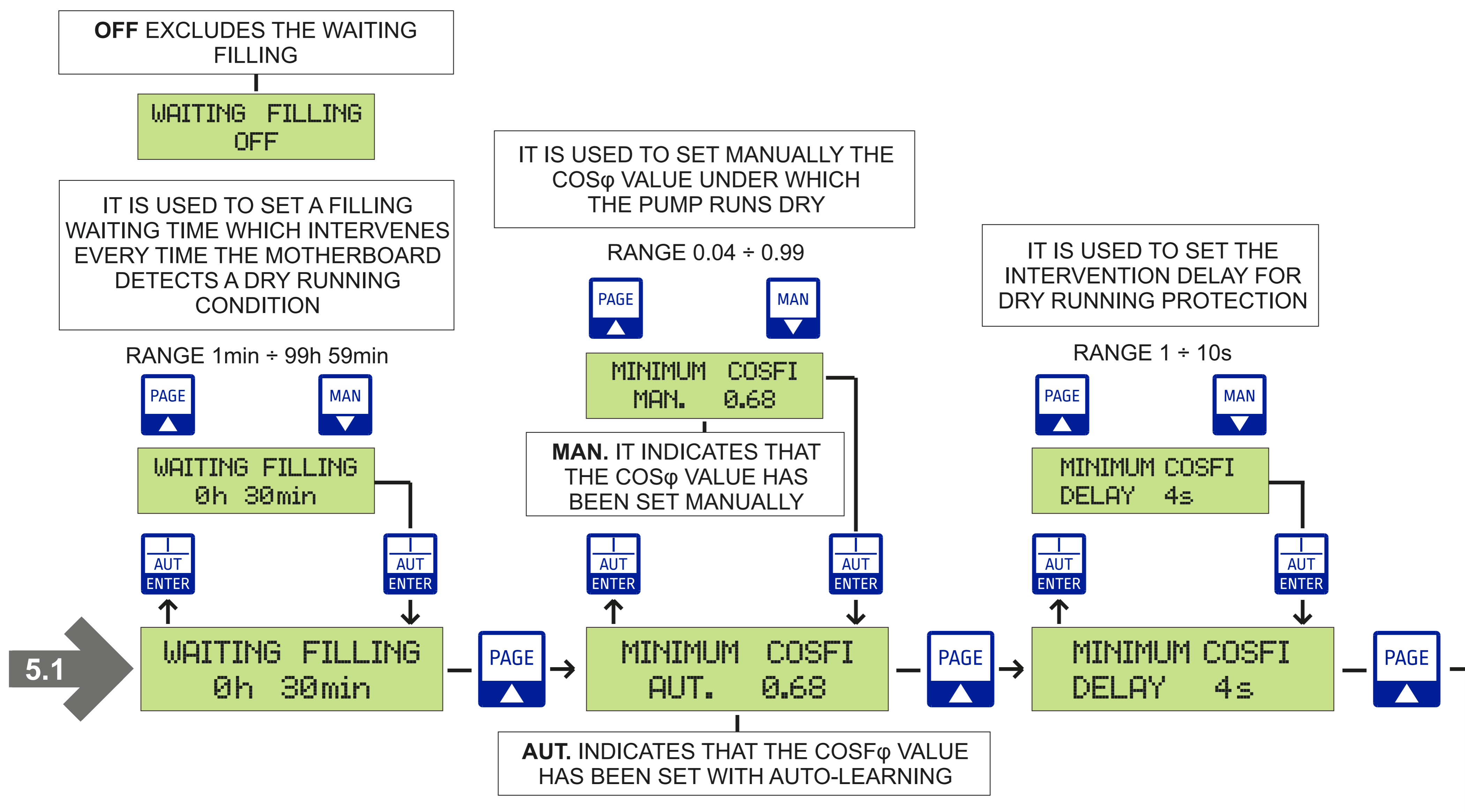

# 5. PROGRAMMING

## 5.3 Application 4-20mA bar

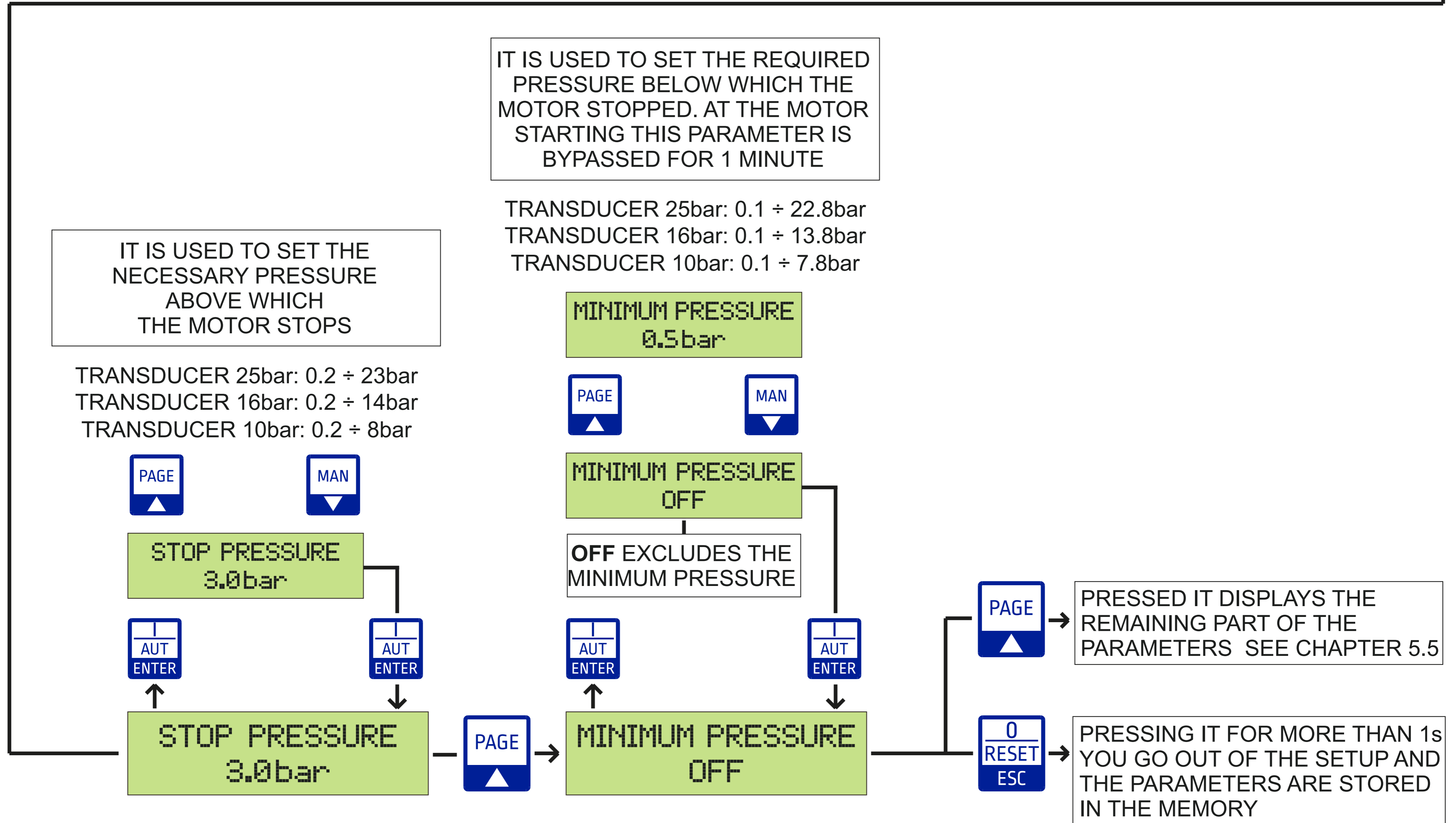
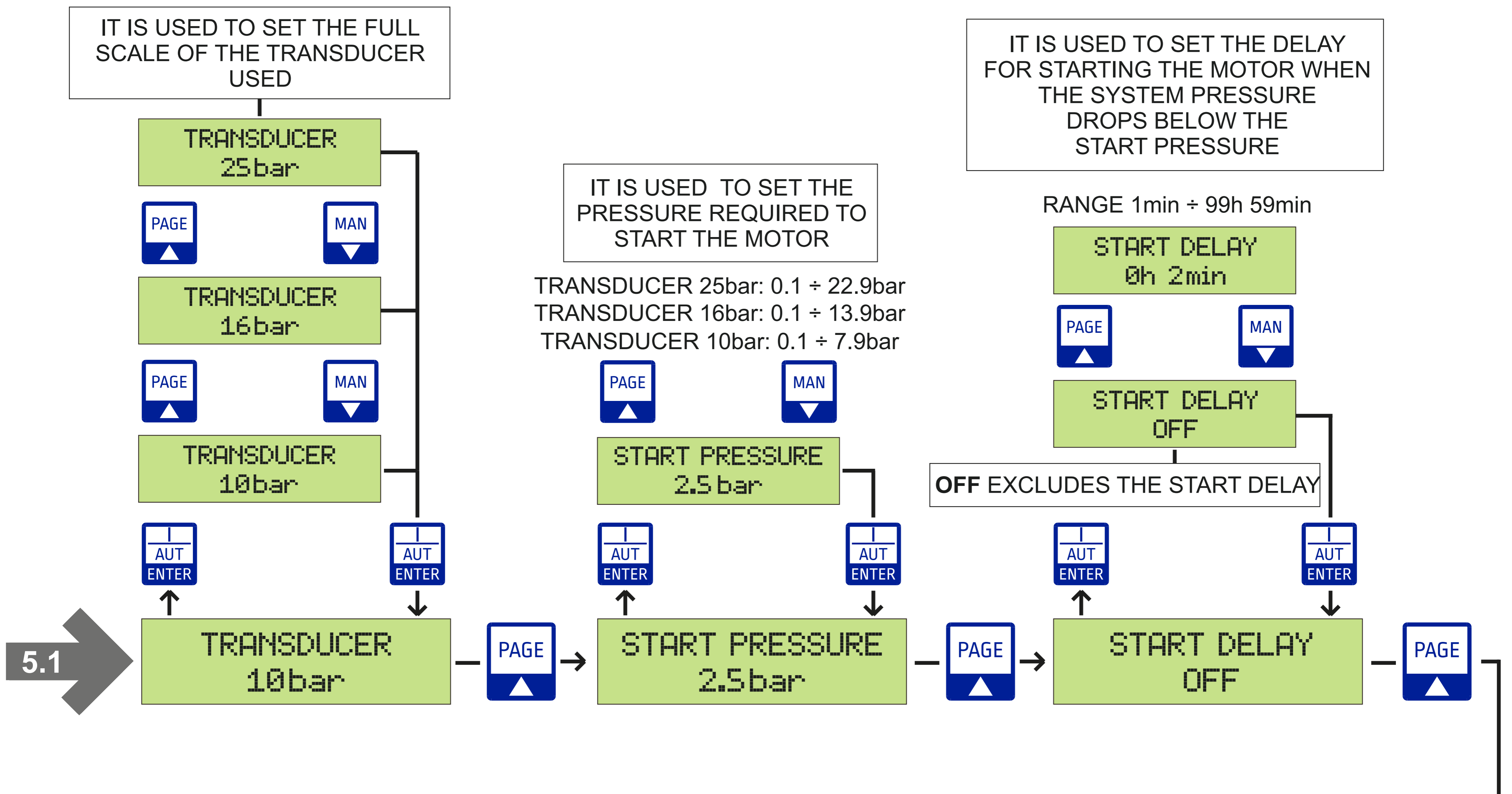

5.4 Application 4-20mA meters

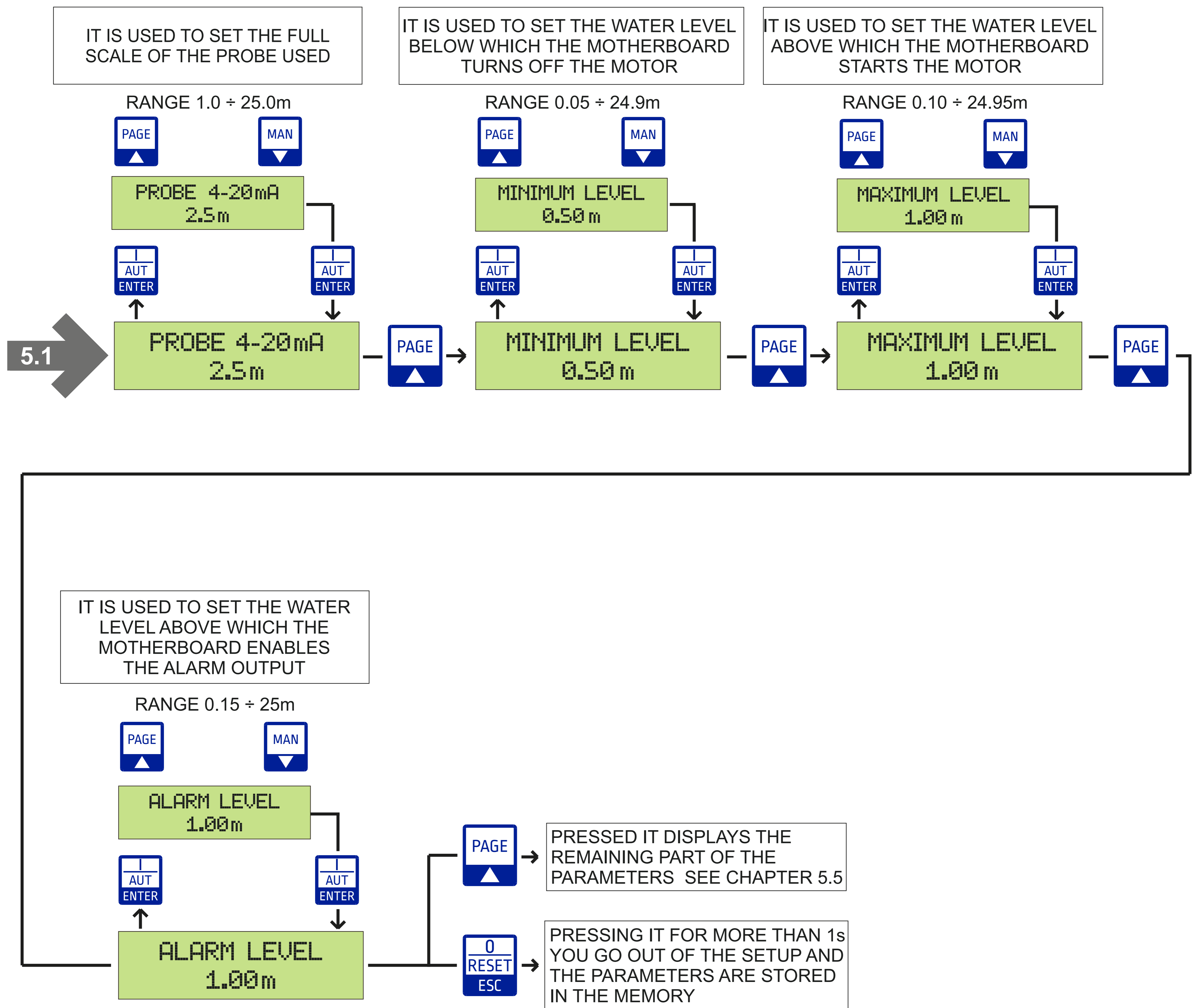

## 5.5 Advanced programming

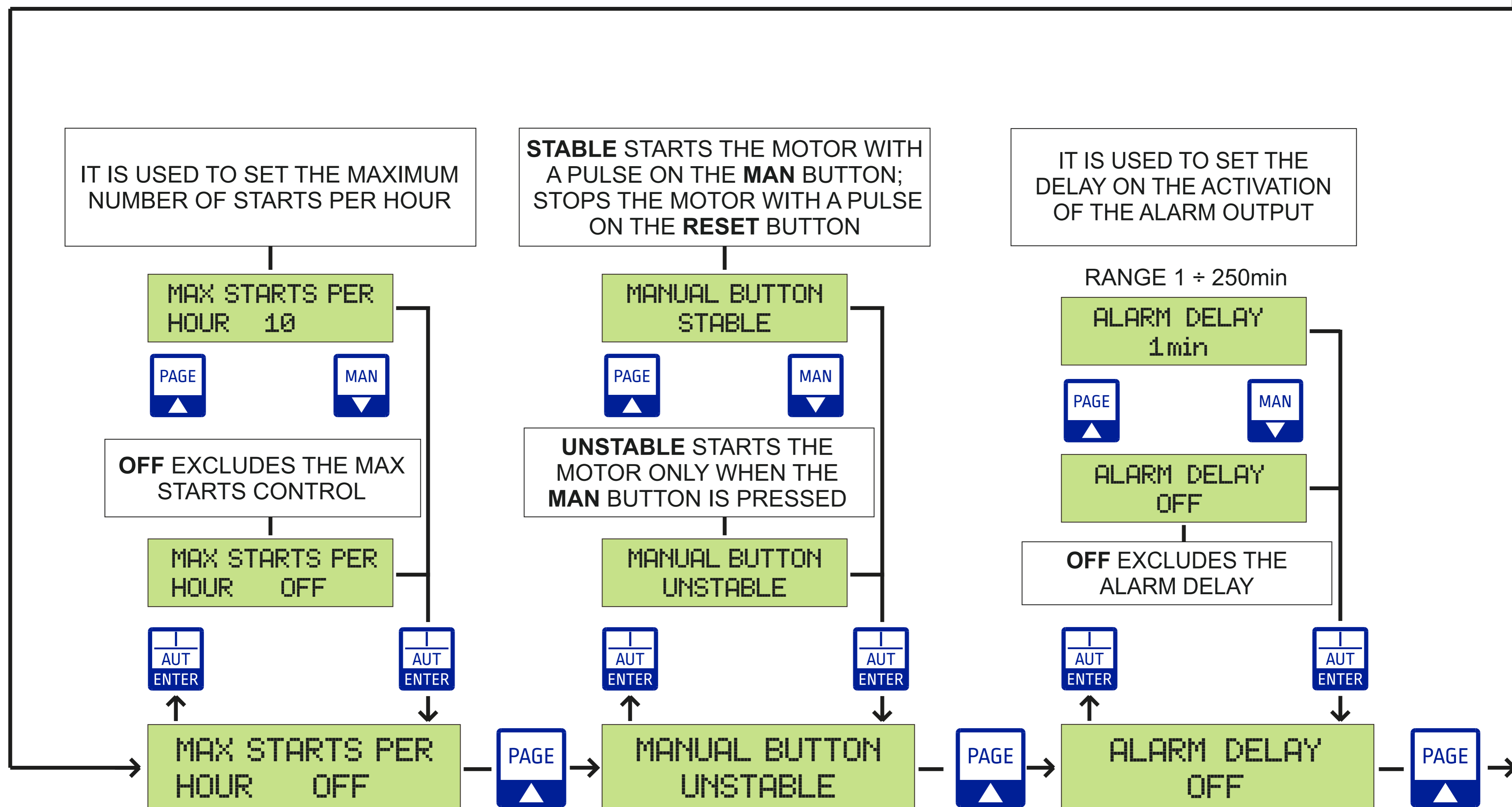
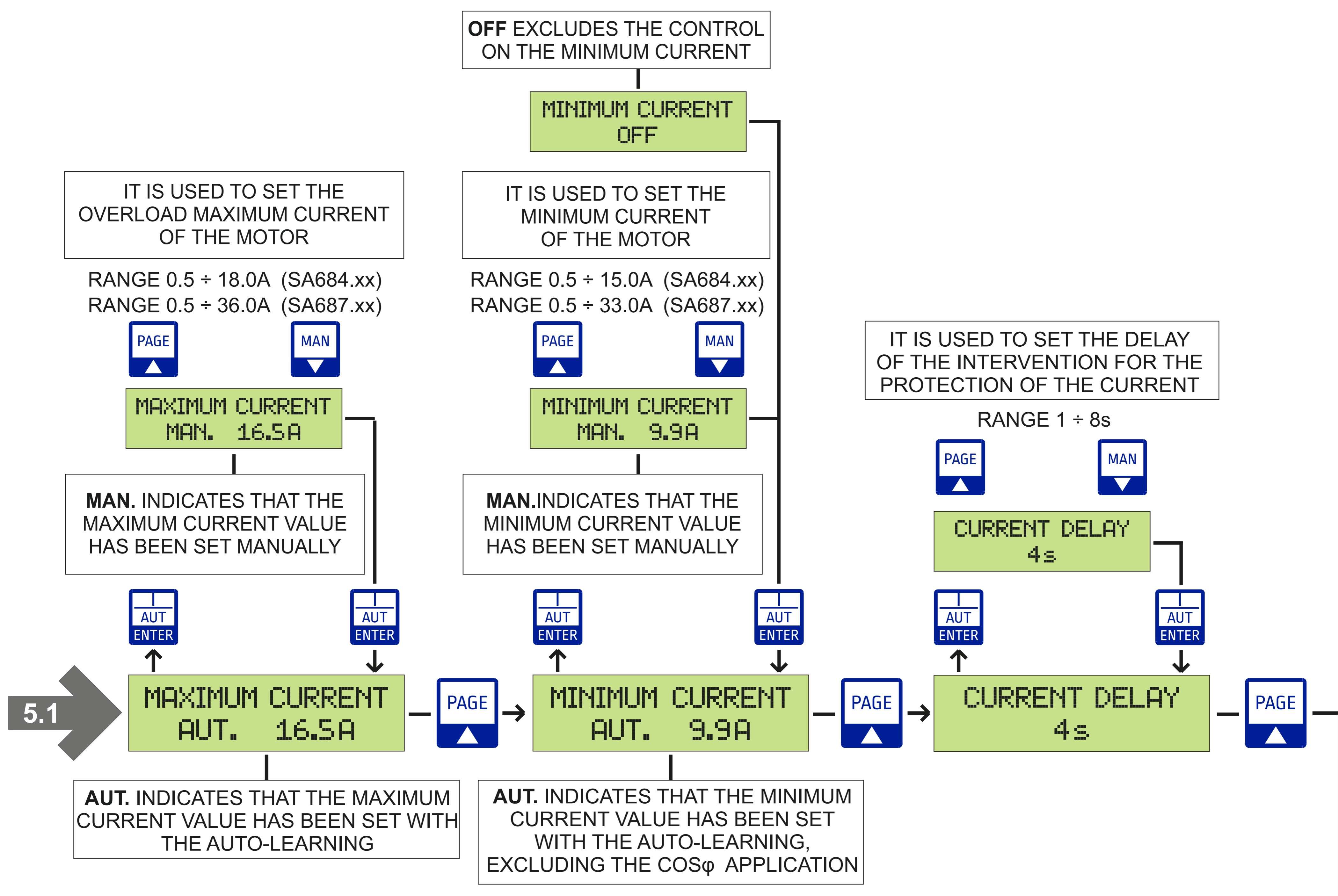

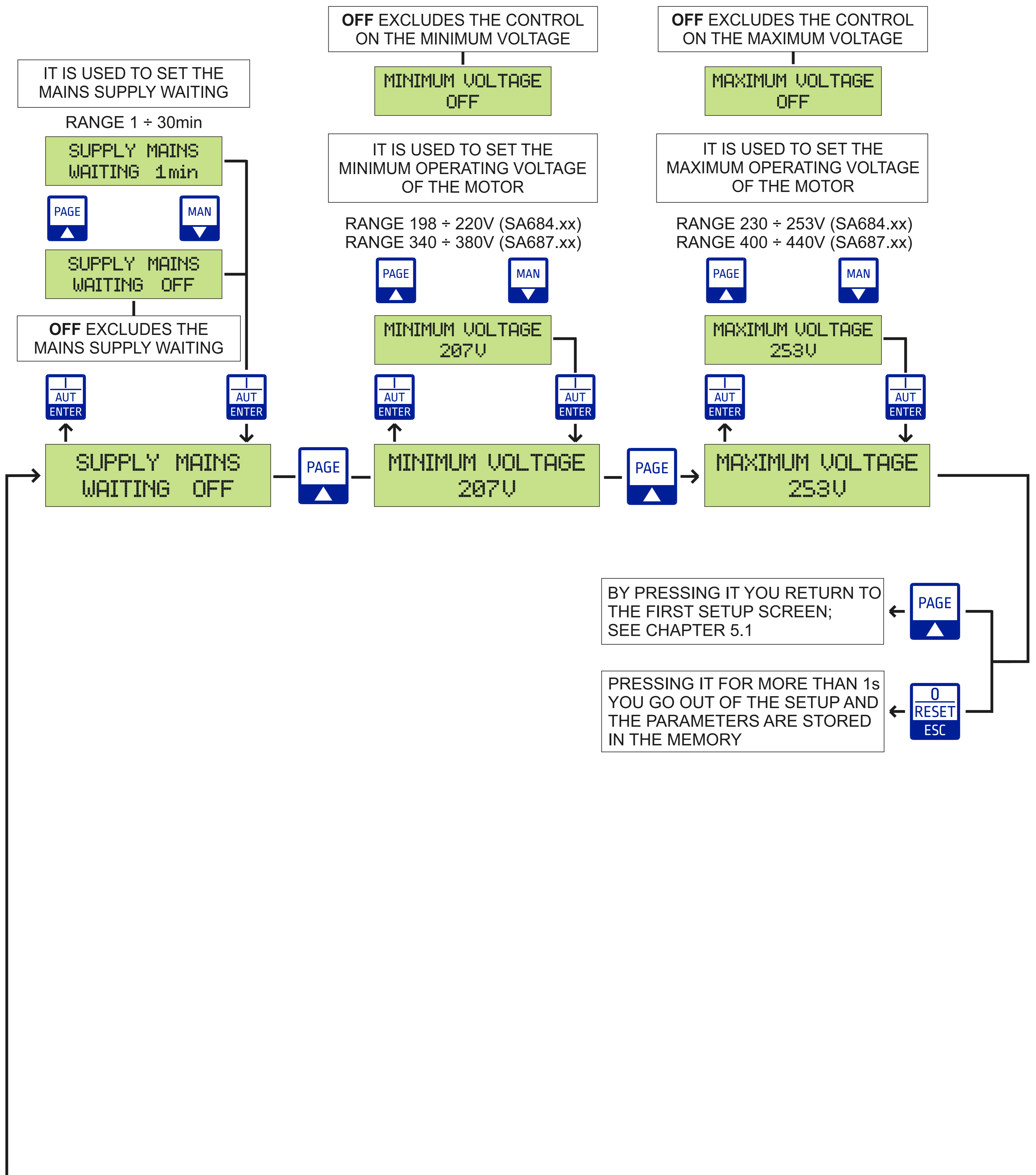

# 6. GENERAL FUNCTIONING OF THE CONTROL PANEL

## 6.1 General functioning

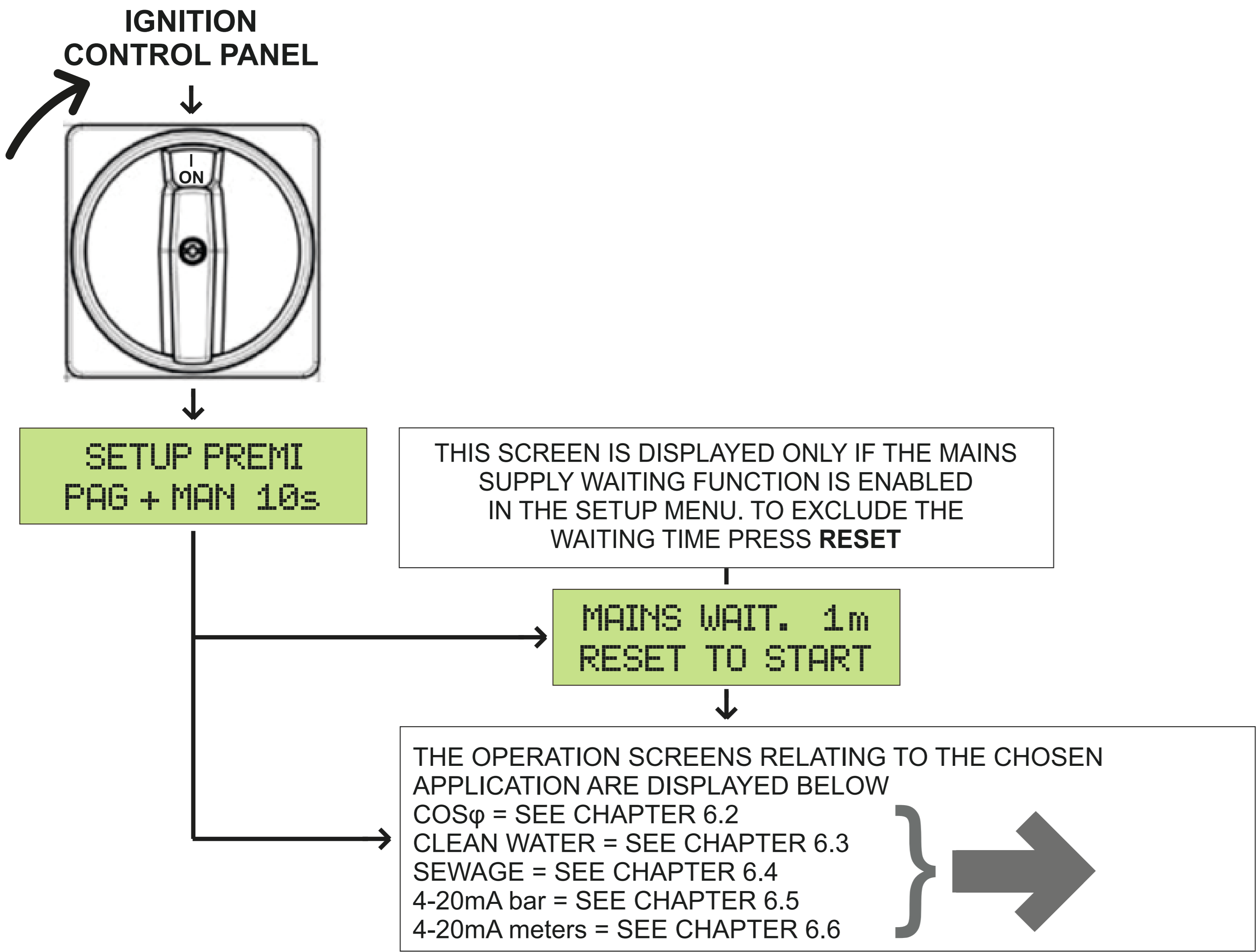

## 6.2 Application cosφ

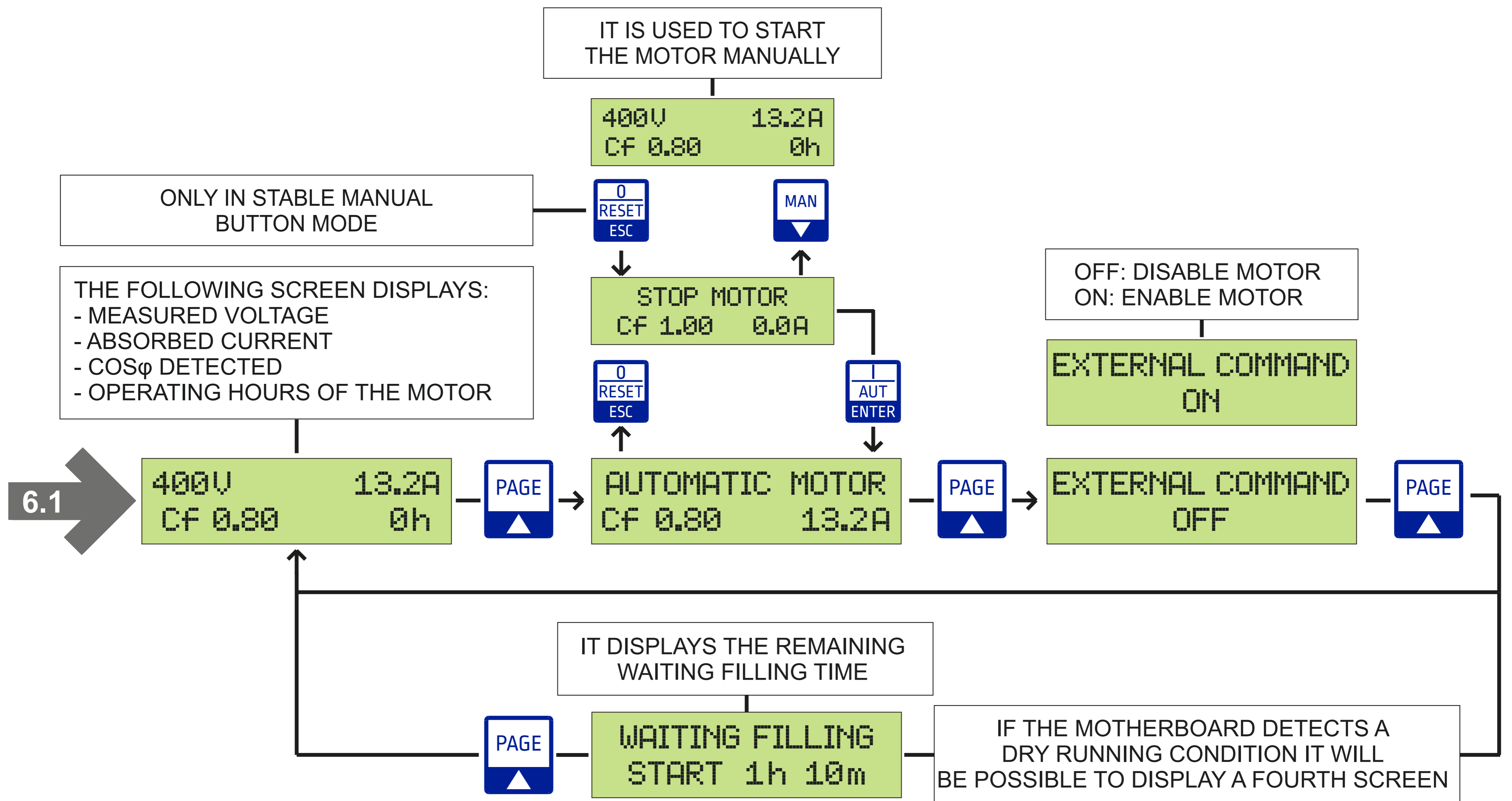

	Pressed the motor goes in STOP function Pressed in case of an alarm it resets it		Pressed it starts the motor in automatic mode
	It is used to scroll through the pages		Pressed in MOTOR STOP status it starts the motor in manual mode



6.3 Application clean water

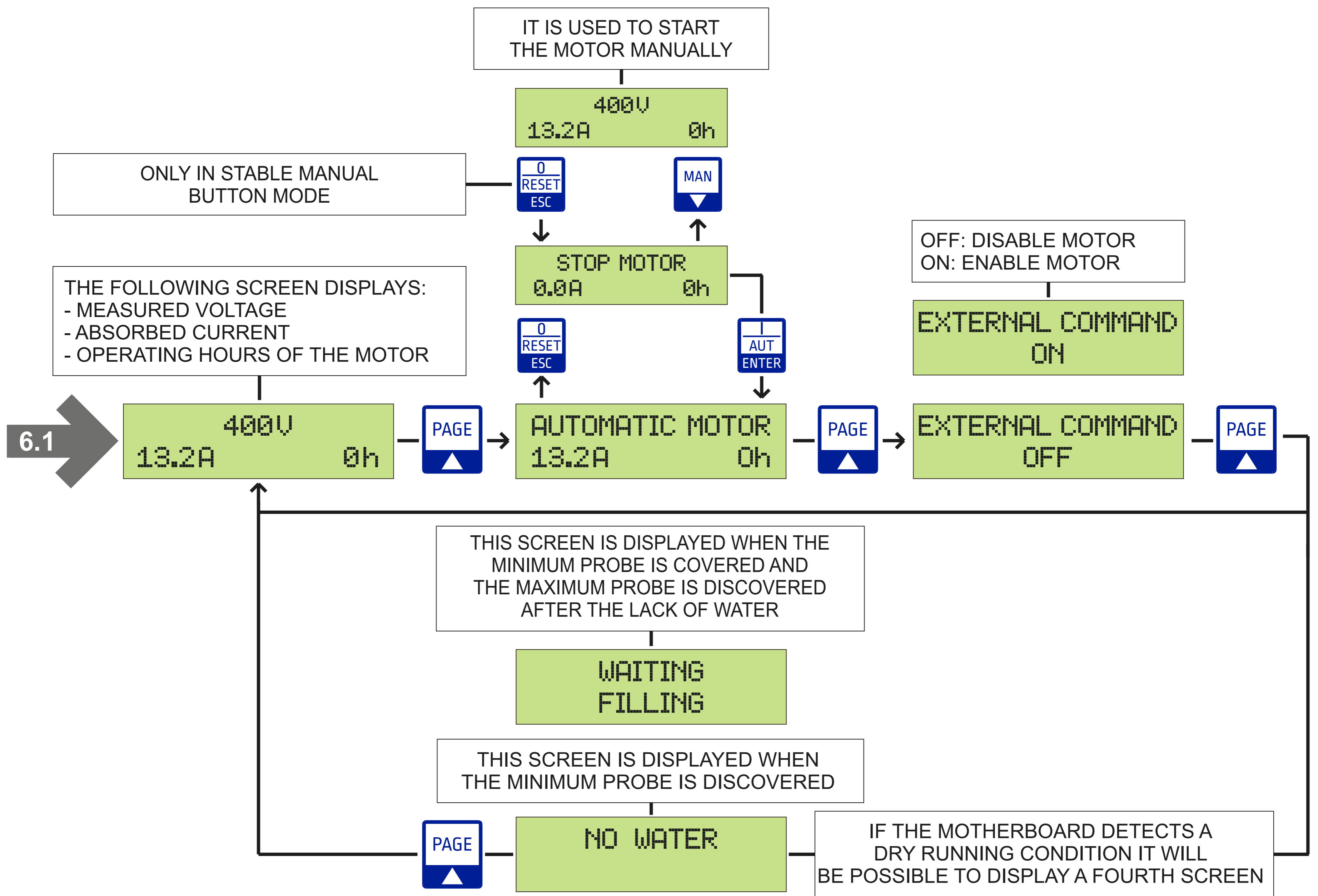

6.4 Application sewage

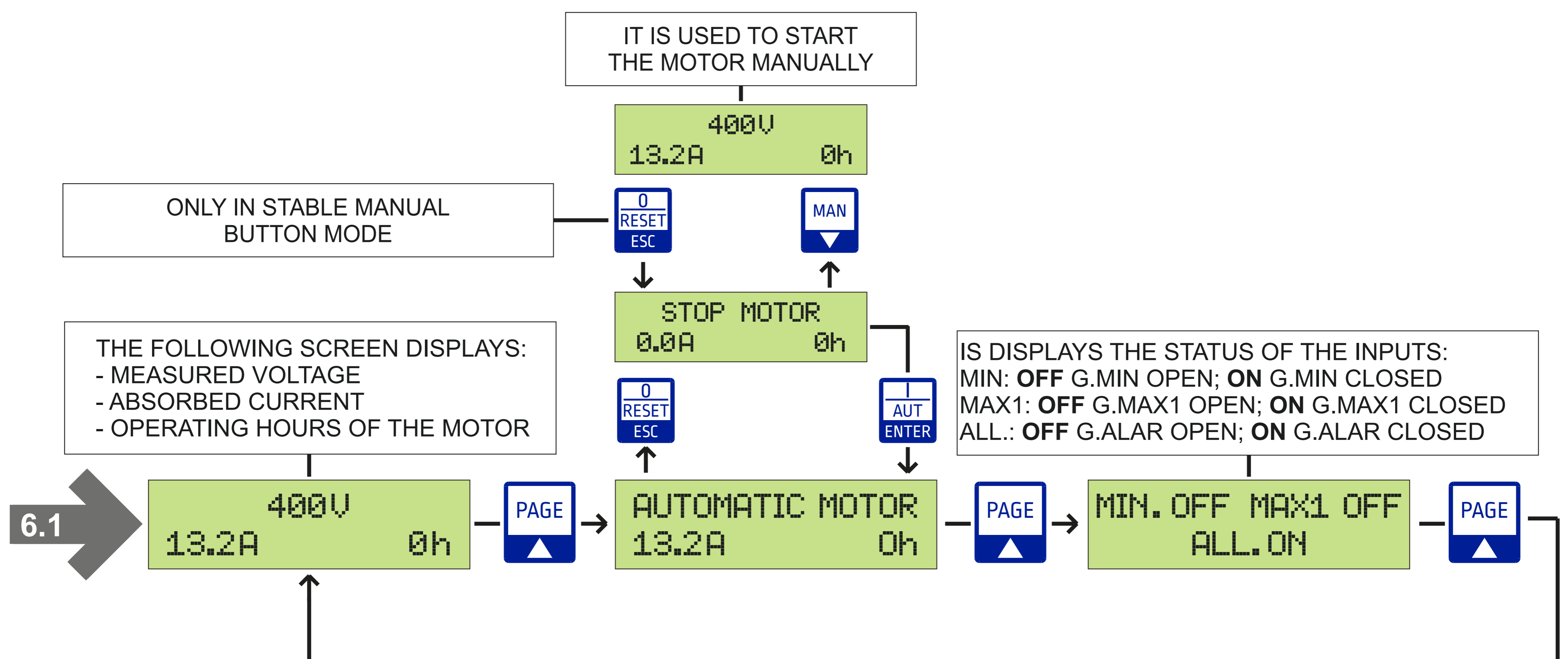

## 6. GENERAL FUNCTIONING OF THE CONTROL PANEL

### 6.5 Application 4-20mA bar

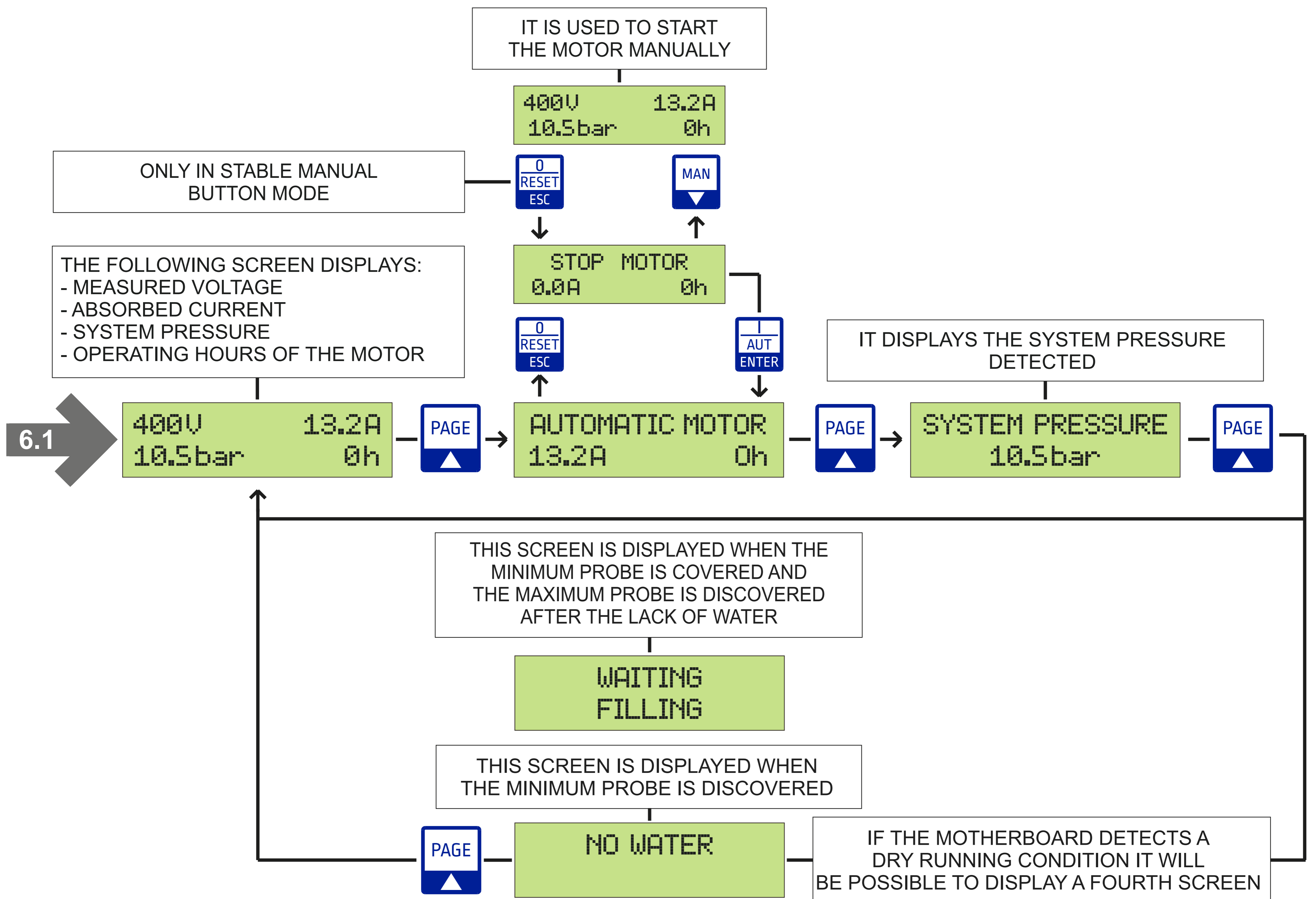

### 6.6 Application 4-20mA meters

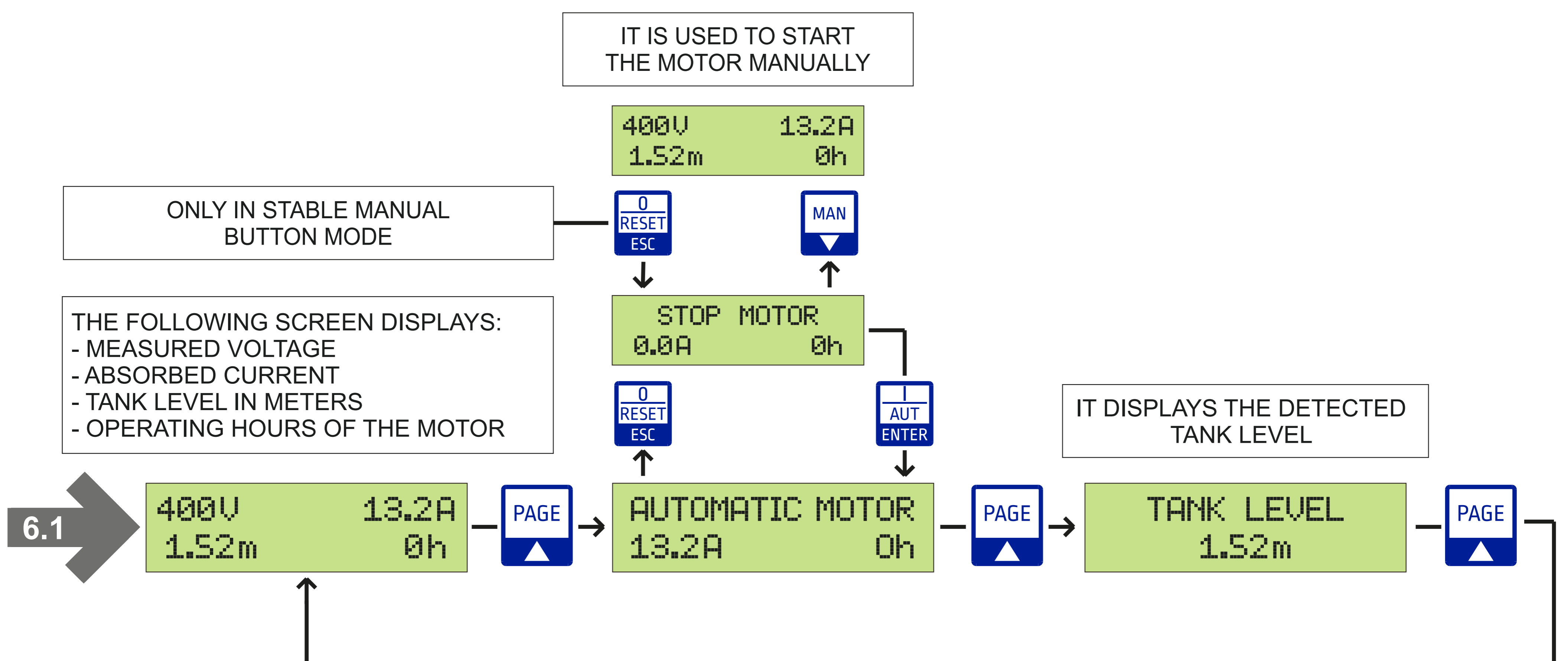

FREQUENT PROBLEMS	CAUSES	OPERATION
Display off	No supply	Feed the control panel respecting the input voltage
	Switch set on 0	Set the switch on 1
	The flat cable inside the control panel is not connected	Connect the flat cable from the motherboard to the display
MAXIMUM CURRENT alarm	Maximum current set on the setup less than that absorbed by the motor	Set manually the maximum current the 25% more than the nominal value
	Motor blocked or damaged	Disconnect the motor and be sure it is working properly
Application COS $\phi$ : EXTERNAL COMMAND OFF with empty tank	Possible failure of the float switch	Ceck the functionality of the float switches and replace if necessary
Application SEWAGE/CLEAN WATER: FLOAT SWITCHES OFF status with full tank	Possible failure of the float switches or connection cable interrupted	Ceck the functionality of the float switches and of the cable and replace if necessary
Application 4-20mA bar: Pressure value in bar displayed in the wrong display	Possible obstruction or failure of the 4-20mA pressure transducer	Clean carefully the pressure transducer or replace if necessary
Application 4-20mA meters: The displayed level in meter is wrong	Possible obstruction or failure of the piezoresistive probe 4-20mA	Clean carefully the piezoresistive probe or replace if necessary

## 8. DATA LOGGER

### 8.1 Alarm data logger

The alarm data logger is used to display the last 20 stored alarms in descending order. The motherboard together with the alarm also records the motor operating hours in which it was generated.

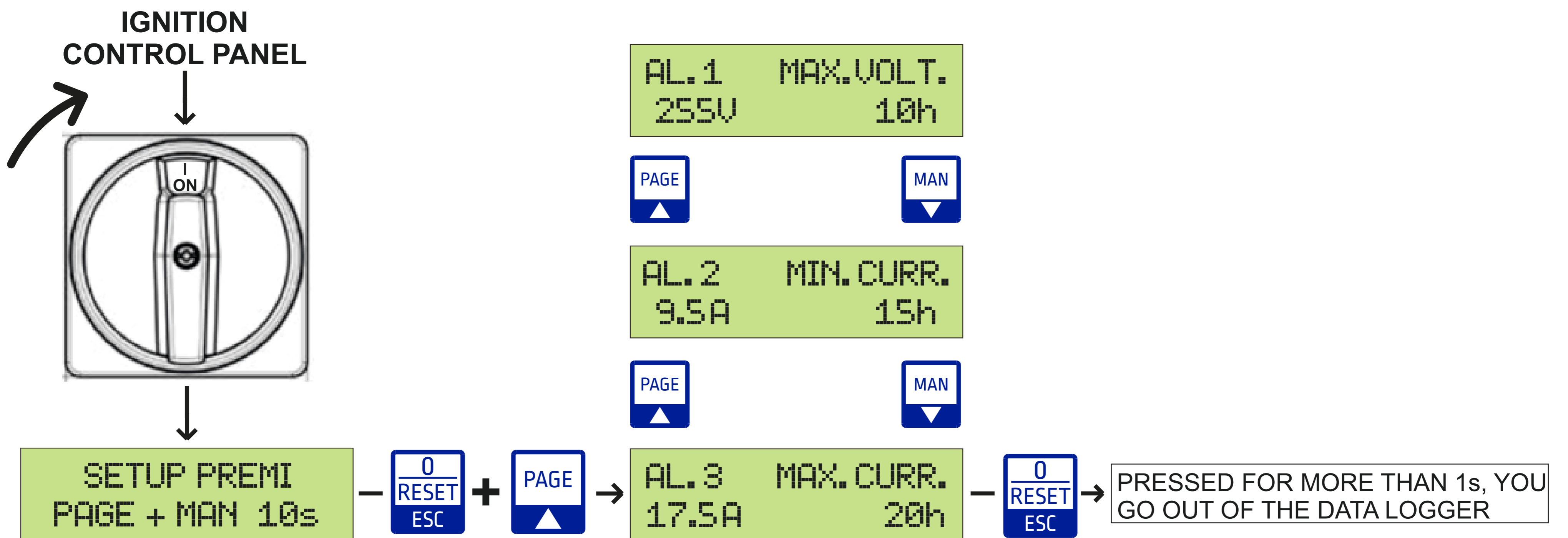

### 8.2 Event data logger

The event data logger is used to display the last 20 changes made in the setup relating to the motor protections in descending order:

- Minimum and maximum voltage
- Minimum and maximum current
- Minimum  $\cos\phi$
- Maximum motor starts per hour

The motherboard together with the event also records the motor operating hours in which it was generated.

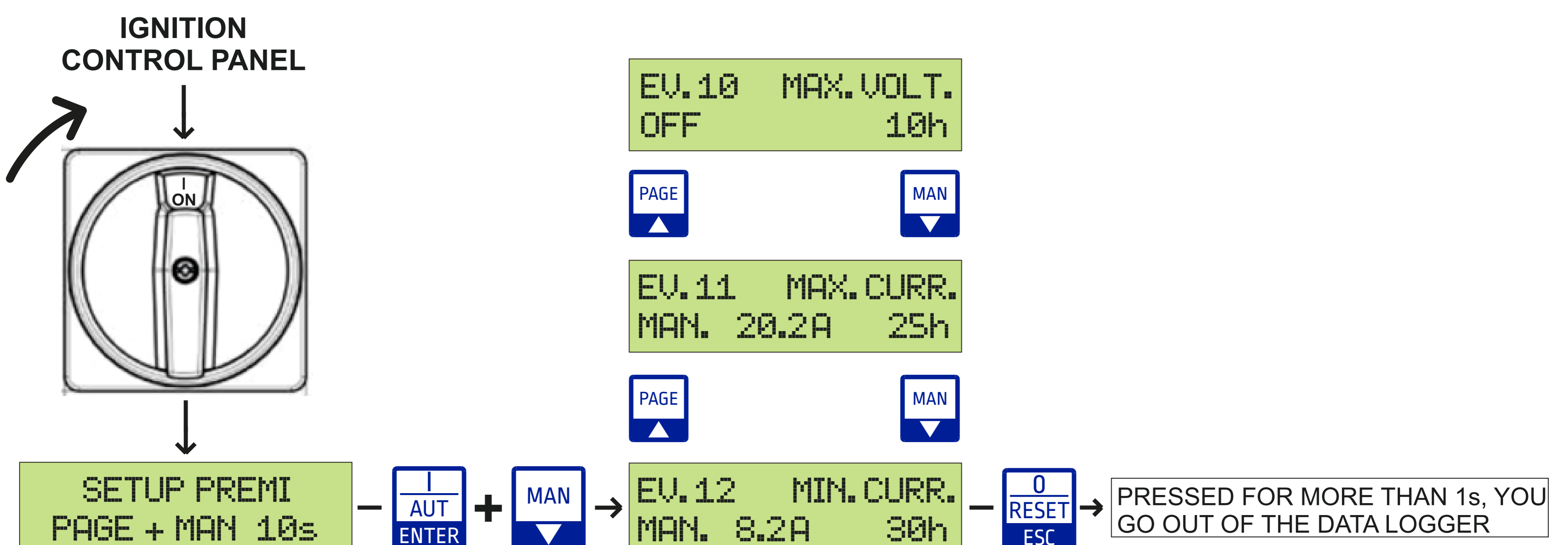

DATA LOGGER	SCREEN	DESCRIPTION
✓	MAXIMUM CURRENT PREMI RESET	If the current absorbed by the motor exceeds that adjusted in the setup, the motherboard will turn off the motor and the display will show the following message.
✓	MINIMUM CURRENT PRESS RESET	If the current absorbed by the motor is lower than the current set in the setup, the motherboard will turn off the motor and the display will show the following message.
✓	ALARM MINIMUM VOLTAGE	If the supply voltage drops below the minimum voltage and this condition persists for 5 seconds the alarm is activated, the motor is no longer powered and you will see the following message. If the voltage is within the set range and stays there for 60 seconds, the motherboard will automatically reset the alarm.
✓	ALARM MAXIMUM VOLTAGE	If the supply voltage exceeds the maximum voltage and this condition persists for 0.5 seconds the alarm is activated, the motor is no longer powered and you will see the following message. If the voltage is within the set range and stays there for 60 seconds, the motherboard will automatically reset the alarm.
✓	ALARM LACK OF PASHE	If the motherboard detects the absence of one of the three phases R, S, or T, (SA687.xx), the display shows the following message.
✓	ALARM REV. RST PHASES	If the sense of the cycle of the input voltages R, S, o, T (SA687.xx) is inverted, the display shows the following message.
✓	MAX STARTS MOT. PRESS RESET	If the number of starts per hour surpasses the preset limit, the motherboard will stop the motor and the display will show the following screen.
✓	KLIXON MOTOR	If the internal temperature of motor exceeds the KLIXON thermal threshold, the motherboard will turn off the motor and the display will show the following message.
	ALARM MAXIMUM LEVEL	If the water level in the tank exceeds the level set in the ALARM LEVEL parameter, the display will show the following screen.
	MINIMUM PRESSURE PRESS RESET	If the pressure in the system falls below the value set in the MINIMUM PRESSURE parameter of the setup, the motherboard will turn off the motor and the display will show the following message.

All alarms are automatically reset except for the maximum current which is reset by pressing the  button for 2 seconds.

In the motherboard, when any type of alarm is generated, three outputs are activated, two 12Vdc inputs respectively for siren and flashing lamp and one with pure contact relay.

By means of the  button it is possible to silence the siren output which will remain deactivated until a new alarm is generated.

## 10. SMALTIMENTO DI VECCHI APPARECCHI ELETTRICI ED ELETTRONICI DISPOSAL OF ELECTRICAL & ELECTRONIC EQUIPMENT

 Questo simbolo sul prodotto o sul suo imballo indica che esso non può essere trattato come rifiuto domestico. Al contrario, dovrà essere portato ad un punto di raccolta determinato per il riciclaggio degli apparecchi elettrici ed elettronici, come ad esempio:

- punti vendita, nel caso si acquisti un prodotto nuovo simile a quello da smaltire
- punti di raccolta locali (centri di raccolta rifiuti, centri locali di riciclaggio, ecc...).

AssicurandoVi che il prodotto sia smaltito correttamente, aiuterete a prevenire potenziali conseguenze negative per l'ambiente e la salute, che potrebbero essere causate da un inadeguato smaltimento di questo prodotto. Il riciclaggio dei materiali aiuterà a conservare le risorse naturali. Per informazioni più dettagliate riguardo il riciclaggio di questo prodotto, contattate per cortesia il Vs. ufficio locale, il Vs. servizio di smaltimento rifiuti domestici o il negozio dove avete acquistato questo prodotto.

 *This symbol on the product or its packaging indicates that it shall not be treated as household waste. Instead, it shall be handed over to the applicable collection point for the recycling of electrical and electronic equipment, such as for example:*

- sales points, in case you buy a new and similar product*
- local collection points (waste collection centre, local recycling center, etc...).*

*By ensuring this product is disposed of correctly, you will help prevent potential negative consequence for the environment and human health, which could otherwise be caused by inappropriate waste handling of this product. The recycling of materials will help to preserve natural resources. For more detailed information about recycling of this product, please contact your local city office, your house hold waste disposal service or the shop where you purchased the product.*

## 11. DICHIARAZIONE DI CONFORMITA' DECLARATION OF CONFORMITY

ELETTROMEK di Germano' Antonino  
Via C. Colombo, 186  
98066 Patti (ME)

Dichiara che:

gli avviatori diretti **MULTIPLUS 1** Monofase e Trifase

sono conformi ai requisiti di protezione in materia di sicurezza (bassa tensione) e di compatibilità elettromagnetica specifici previsti dalle Direttive della Comunità Europea 2006/95/CEE del 16 Gennaio 2007, 2004/108/CE del 10 Novembre 2007, 93/68/CEE del 22 Luglio 1993. Conformità CEI EN61439-1, EN 61000-6-3, EN 61000-6-1 DIN VDE 0113/EN60204-1 / IEC 204-1.

MANAGING DIRECTOR  
Germanò Antonio



ELETTROMEK di Germano' Antonino  
Via C. Colombo, 186  
98066 Patti (ME)

Declares that:

the Single-phase and Three-phase **MULTIPLUS 1** direct starters

comply with the specific protection prerequisites concerning both safety (low voltage) and the electromagnetic compatibility provided for by the European Community laws 2006/95/CEE of 16th January 2007, 2004/108/CE of 10th November 2007, 93/68/CEE of 22th July 1993. Compliance CEI EN61439-1, EN 61000-6-3, EN 61000-6-1 DIN VDE 0113/EN60204-1 / IEC 204-1.

MANAGING DIRECTOR  
Germanò Antonio







**ELETTROMEK**

Via C. Colombo, 186

98066 Patti (ME) ITALY

Tel.:+39 - (0) 941 - 361336

Fax:+39 - (0) 941 - 372806

**[www.xpowerwaterpumps.com](http://www.xpowerwaterpumps.com)**

e-mail: **[info@xpowerwaterpumps.com](mailto:info@xpowerwaterpumps.com)**

